

Overview

HPE ProLiant ML110 Gen11

Provide enhanced single processor and storage flexibility in a 4.5U 1P tower optimized server with optional rackable chassis, outstanding compute performance, security, reliability, and expandability at an affordable price. Fill a mid-range of workloads for small offices, remote and branch offices of large enterprises, growing SMBs and data centers with the power of 4th Gen Intel® Xeon® Scalable Processors (up to 32 cores) increased bandwidth with DDR5 and PCIe Gen5. HPE ProLiant ML110 Gen11 server is an excellent choice to accelerate your growing business.

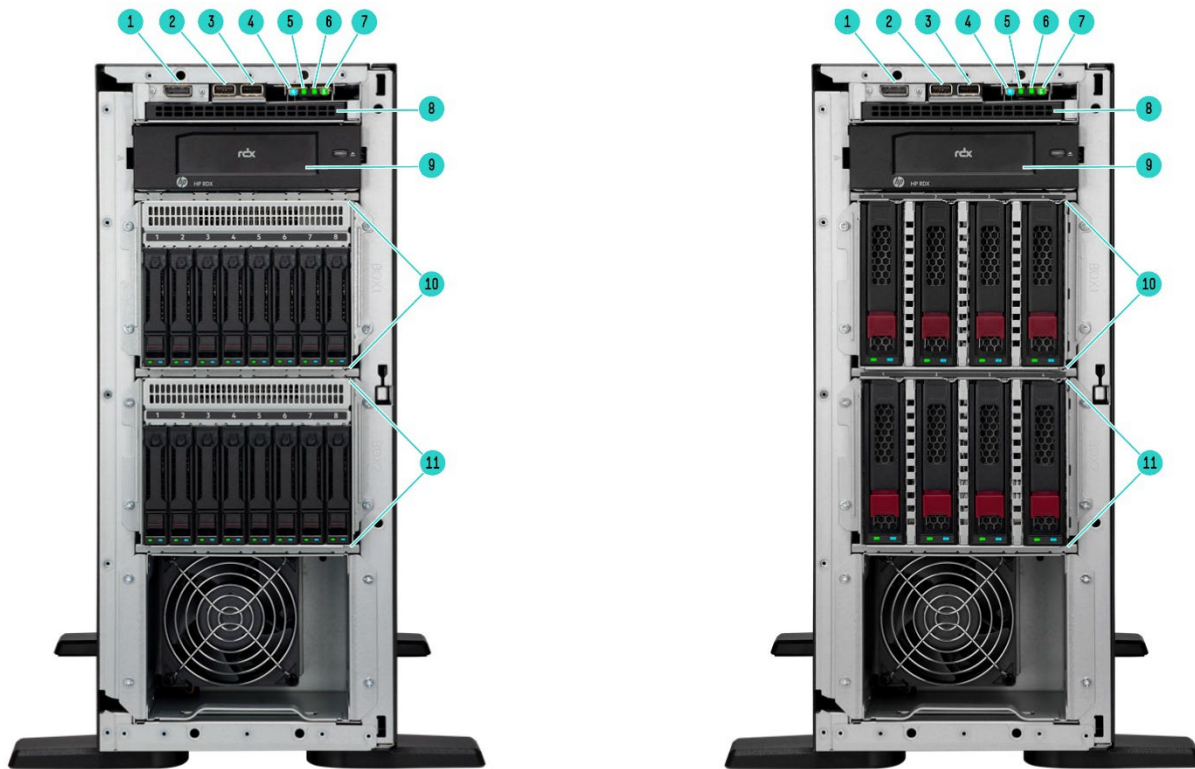

Front View – SFF chassis with optional Gen11 16 SFF and 8LFF Drive Cage Kits with RDX shown (Tower mode)

- | | |
|----------------------|---|
| 1. DisplayPort 1.1a | 7. Power on/Standby button and system power LED |
| 2. USB 3.2 Gen1 port | 8. Optical drive bay |
| 3. iLO service port | 9. Media Bay: optional internal USB RDX docking station |
| 4. UID button/LED | 10. Box1: 4LFF/NHP or 8SFF SAS/SATA drive cage |
| 5. NIC status LED | 11. Box2: Optional 4LFF/NHP or 8SFF SAS/SATA drive cage |
| 6. Health LED | |

Notes: Image shown without the security front bezel which is standard in every ML110 Gen11 unit.

Overview

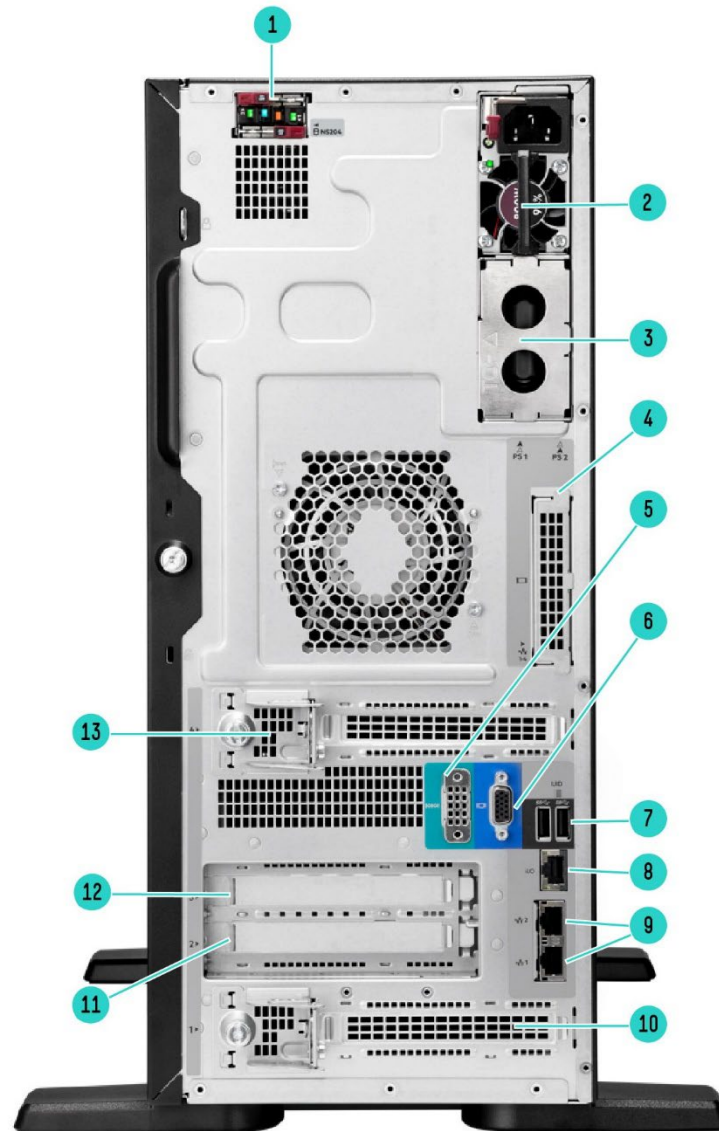

Rear View – With optional NS204i-u and riser kit shown.

- | | |
|--|--|
| 1. HPE NS204i-u Gen11 NVMe Hot Plug Boot Device (Optional) | 8. iLO management port |
| 2. Flexible Slot power supply 1 | 9. Dual NIC ports (1 GbE) |
| 3. Flexible Slot power supply 2 | 10. Slot 1 PCIe5 x16 |
| 4. Slot 14 OCP 1 (Optional for OROC/NIC OCP adapter) | 11. Slot 2 PCIe5 x16 (Optional riser kit required) |
| 5. Serial port (Optional) | 12. Slot 3 PCIe5 x16 (Optional riser kit required) |
| 6. VGA Port | 13. Slot 4 PCIe5 x16 |
| 7. Dual USB 3.2 Gen 1 ports | |



Overview

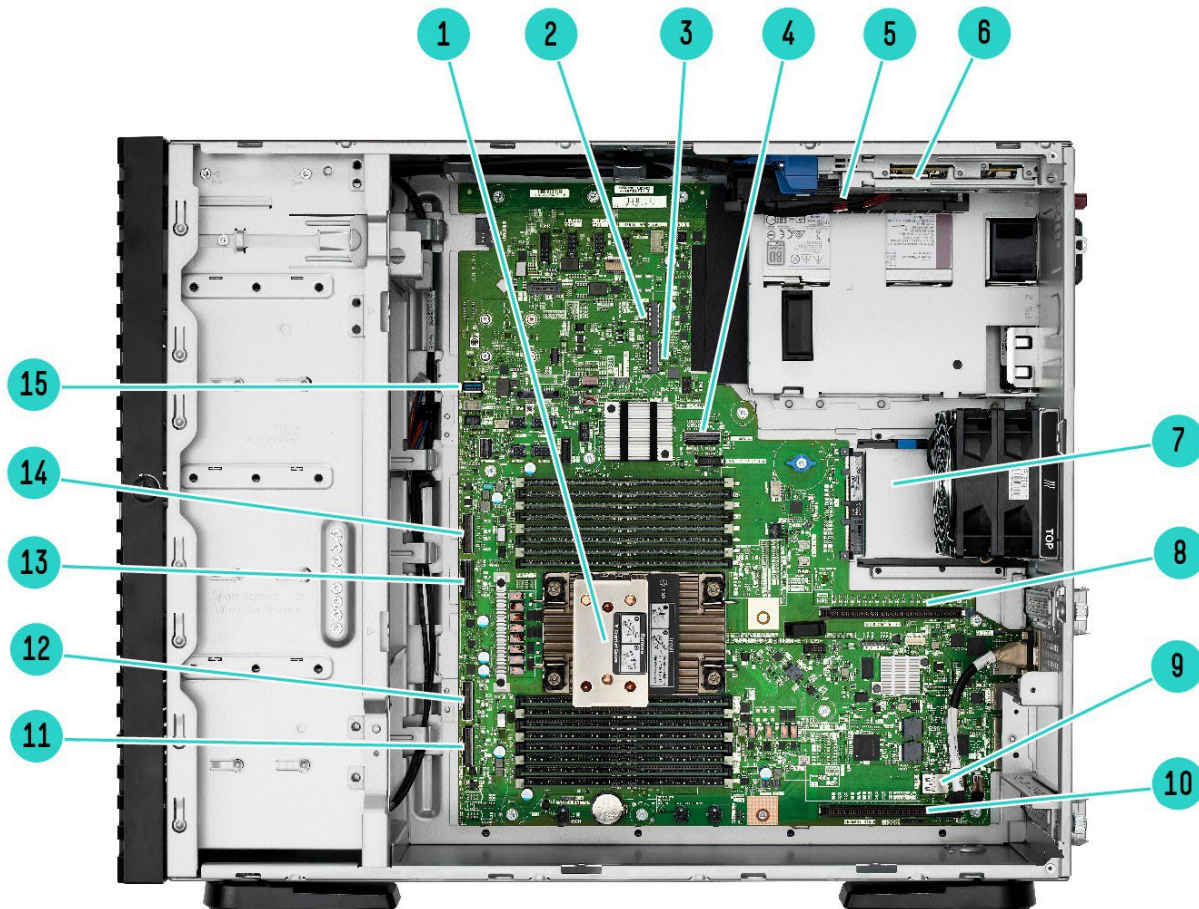

Internal View – with full memory DIMM populated and optional NS204i-u shown

- | | |
|--|--------------------------------------|
| 1. CPU Socket with 16 DDR5 DIMM slots | 9. USB 2.0 port |
| 2. M.2 Slot 2 | 10. Slot 1 PCIe5 x16 |
| 3. M.2 Slot 1 | 11. MCI0 port 1 for the riser slot 2 |
| 4. x8 SlimSAS port | 12. MCI0 port 2 for the riser slot 2 |
| 5. Megacell battery holder (Under) | 13. MCI0 port 3 for the riser slot 3 |
| 6. HPE NS204i-u NVMe Hot Plug Boot Device (Optional) | 14. MCI0 port 4 for the riser slot 3 |
| 7. Slot 14 OCP 1 (Optional for OROC/NIC) | 15. USB 3.2 Gen 1 port |
| 8. Slot 4 PCIe5 x16 | |



Overview

What's New

- Powered by 4th Generation Intel® Xeon® Scalable processors that support up to 32 core at 185W, 60 MB of L3 Cache, and 16 DIMMs for DDR5 memory up to 4800 MT/s.
- Increased memory bandwidth, performance and lower power requirements with DDR5 memory that support up to 1 TB memory capacity with 8 channels per processor.
- Advanced data transfer rates from the PCIe Gen5 serial expansion bus.
- Includes HPE Integrated Lights-Out 6 (iLO 6) server management software that enables you to securely configure, monitor, and update your HPE ProLiant Gen11 servers seamlessly from anywhere.
- Supports LFF/SFF backplane and hot-pluggable RAID1 protected NS204i-u M.2 NVMe boot option.
- Support NVIDIA L4 24GB PCIe Accelerator

Platform Information

Form Factor

- 4.5U tower with rack conversion capability

Notes: When deployed as a Rack model, this system will take up 5.5U-height space in a standard data center rack facility.

Chassis Types

- 8 SFF chassis with optional SFF drive cage kit, 1 Optical Drive, 1 USB internal RDX docking station supported.
- 4 LFF chassis with optional LFF or SFF drive cage kit, 1 Optical Drive, 1 USB internal RDX docking station supported.

Notes: Mixed SFF and LFF drive cages is supported with LFF chassis, up to 2 drive cages.

System Fans

- Standard – 2 fans included with optional Redundant Fan Kit.

Notes:

When one of the following scenarios occurs, Redundant Fan Kit (P49984-B21) is required.

- Server with the following options installed:
 - o SAS 15K RPM SFF HDD.
 - o SAS4 SFF SSD drives consume power equal to or higher than 15W.
 - o HPE NS204i-u Gen11 NVMe Hot Plug Boot Optimized Storage Device.
 - o GPU and accelerators
 - Server is required to continue operating with single fan failure. A flashing amber Health LED will indicate this condition.
 - Server is required to operate with the A3/A4 extended operating environment with ambient temperature 35°C (95°F) to 45°C (113°F).
-



Standard Features

Processors – One of the following, depending on model.

Notes: For more information regarding Intel Xeon processors, please see the following

<https://www.intel.sg/content/www/xa/en/processors/xeon/scalable/xeon-scalable-platform.html>.

Intel Fourth Generation Xeon® Scalable Processors – Naming Decoder

Processor Suffix	Description	Offering
P	Cloud – IaaS	Optimized for high performance IaaS for orchestration efficiency - IaaS higher freq. for VM environments
V	Cloud – SaaS	Designed for high rack density, maximize VM/core, and lower power VM environment
M	Media Transcode	Designed for Media Processing and Transcoding
H	DB and Analytics	Designed for Data Analytics and Big Data usages. Maximum capability for IAA, DSA, QAT, DLB and AMX. Supported on 2, 4 and 8 socket platforms.
N	Network/5G/Edge(High TPT/Low Latency)	Designed and optimized for a range of broadly-deployed network and 5G workload environments from edge to the data center. Support network solutions with lower latency, higher throughput, deterministic performance and extended supply life. Maximum capability for DLB, DSA and QAT – for Dynamic Load Balancing, Data Movement and Cryptography/Data Compression. 1S SKUs –Optimized for Network (default mode), CSP (Cloud mode) and Enterprise (Server mode)
S	Storage & HCI	Designed to provide maximum inter-socket bandwidth with lower core counts and TDPs. Extended product supply life. Maximum capability for DSA, QAT and DLB – for Data Movement and Data Compression
T	Long-life Use/High Tcase	Support for up to 10-year reliability. Select SKUs offer use for industrial commercial temperature conditions. Long life availability
U	1-Socket Optimized*	Provides cost-effective 1S options at lower core counts, largely for Enterprise
Q	Liquid cooling	Provides higher frequencies
+	Feature +	Feature Plus SKU – Enabled 1 for each accelerator device of QAT, DLB, DSA, IAX

Intel Fourth Generation Xeon® Scalable Processors

Intel Xeon Models	CPU Frequency	Cores	L3 Cache	Power	UPI (16 GT/s)	DDR5	SGX Enclave size
Gold Processors							
Gold 6426Y Processor	2.5 GHz	16	37.5 MB	185W	3	4800 MT/s	128 GB
Gold 6421N Processor*	1.8 GHz	32	60 MB	185W	N/A	4400 MT/s	128 GB
Gold 5418Y Processor	2.0 GHz	24	45 MB	185W	3	4400 MT/s	128 GB
Gold 5412U Processor*	2.1 GHz	24	45 MB	185W	N/A	4400 MT/s	128 GB
Gold 5411N Processor*	1.9 GHz	24	45 MB	165W	N/A	4400 MT/s	128 GB
Gold 5418N Processor	1.8 GHz	24	45 MB	165W	3	4000 MT/s	128 GB
Gold 5415+ Processor	2.9 GHz	8	22.5 MB	150W	3	4400 MT/s	128 GB
Gold 5416S Processor	2.0 GHz	16	30 MB	150W	3	4400 MT/s	128 GB
Silver Processors							
Silver 4416+ Processor	2.0 GHz	20	37.5 MB	165W	2	4000 MT/s	64 GB
Silver 4410Y Processor	2.0 GHz	12	30 MB	150W	2	4000 MT/s	64 GB
Bronze Processor							
Bronze 3408U Processor*	1.8 GHz	8	22.5 MB	125W	N/A	4000 MT/s	64 GB

Notes:

- 80 PCIe 5.0 lanes per processor.
- * “U” processors (i.e. 5412U, 3408U) and 6421N, 5411N are only supported in single socket configuration.
- The maximum memory speed and capacity is a function of the memory type, memory configuration, and processor model.

Standard Features

Chipset

Intel® C741 Chipset

Notes: For more information regarding Intel® chipsets, please see the following URL:

<https://www.intel.com/content/www/us/en/products/chipsets/server-chipsets.html>

System Management Chipset

HPE iLO 6 ASIC

Notes: Read and learn more in the [iLO QuickSpecs](#).

Memory

One of the following depending on model

Type	HPE DDR5 Smart Memory, Registered (RDIMM)
DIMM Slots Available	16 DIMM slots 16 DIMM slots per processor, 8 channels per processor, 2 DIMM per channel
Maximum capacity (RDIMM)	1.0TB 16 x 64 GB RDIMM @ 4400MT/s at 2 DPC, 16 x 256 GB RDIMM @ 4800 MT/s at 1 DPC

Notes:

- The maximum memory speed and capacity is a function of the memory type, memory configuration, and processor model.
- Mixing of RDIMM and LRDIMM memory is not supported.
- For additional information, please see the [HPE DDR5 Smart Memory QuickSpecs](#).
- For General Server Memory and Persistent Memory Population Rules and Guidelines for Gen11 see details here: <http://www.hpe.com/docs/memory-population-rules>

Memory Protection

Advanced ECC

Advanced ECC uses single device data correction to detect and correct single and all multibit error that occurs within a single DRAM chip.

Online Spare

Memory online spare mode detects a rank that is degrading and switches operation to the spare rank.

Notes: For more information see our [Memory RAS feature technical whitepaper](#).

Expansion Slots

Default Slots

Notes:

- Bus width indicates the number of physical electrical lanes running to the connector.
- There are two PCIe Gen5 x16 slots is available by default:

Default Slots					
Slots #	Processor	Technology	Bus Width	Connector Width	Slot Form Factor
1	CPU 1	PCIe 5.0	X16	X16	Full-height, full-length slot
4	CPU 1	PCIe 5.0	X16	X16	Full-height, half-length slot



Standard Features

Optional GPU Riser Kit

Notes:

- Bus width indicates the number of physical electrical lanes running to the connector.
- Double Width expansion card is only supported with slot 2 and results slot 3 space been occupied.
- Two GPU Riser Kit types:
 - o HPE ProLiant ML110 Gen11 GPU Riser Kit (P53487-B21) provides Slot 2 as PCIe Gen5 x16 slot included riser cage, PCA and cables.
 - o HPE ProLiant ML110 Gen11 Second GPU Riser Kit (P53488-B21) provides Slot 3 as PCIe Gen5 x16 slot included PCA and cables only, Thus HPE ProLiant ML110 Gen11 GPU Riser Kit (P53487-B21) is required while Second GPU riser kit selected.

HPE ProLiant ML110 Gen11 GPU Riser Kit

Slots #	Processor	Technology	Bus Width	Connector Width	Slot Form Factor
2	CPU 1	PCIe 5.0	X16	X16	Full-height, full-length slot
3	CPU 1	PCIe 5.0	X16	X16	Full-height, full-length slot

Internal Storage Devices

- **Optical Drive**
Available as an option (DVD-ROM or DVD-RW)
- **Hard Disk Drive/ Solid State Drive**
Available as an option

Storage Controllers

NVMe Boot Devices

- HPE NS204i-u Gen11 NVMe Hot Plug Boot Optimized Storage Device

Software RAID

- **Intel VROC SATA for HPE ProLiant Gen11**

Notes:

- All models feature an embedded storage controller, with embedded software SATA RAID support for up to 8 LFF or 8 SFF bays and 2 M.2 SATA drives with onboard slots.
- When NS204i-u selected, embedded storage controller port will be occupied and no LFF/SFF bay is supported.
- Intel VROC for HPE ProLiant Gen11 is an enterprise, hybrid Software RAID solution specifically designed for SSDs.
- Intel VROC is a software-based solution utilizing Intel CPU to RAID or HBA direct connected drives.
- RAID Support- 0/1/5/10.
- Windows and Linux OS support.
- Host Tools- Windows GUI/CLI, Linux CLI.
- UEFI Support- HII Utility, OBSE.
- iLO Support- IML, Alert, SNMP, AHS.
- iLO Redfish- Redfish Read .
- Intel VROC SATA for HPE ProLiant Gen11 will operate in UEFI mode only. For legacy support an additional storage controller will be needed.
- Intel VROC SATA is off by default and must be enabled.

- **Intel VROC NVMe for HPE ProLiant Gen11**

Notes:

- All models feature two M.2 slots for NVMe connectivity, provides support for up to two M.2 NVMe drives with onboard slots.



Standard Features

- Intel VROC for HPE ProLiant Gen11 is an enterprise, hybrid Software RAID solution specifically designed for NVMe SSDs connected directly to the CPU. Intel VROC is a software-based solution utilizing Intel CPU to RAID or HBA direct connected drives.
- Intel Virtual RAID on CPU Standard for RAID 0/1/10 (S0E37A/S0E38AAE) or Premium SKU for RAID 0/1/5/10 (R7J57A/R7J59AAE) must be ordered to enable RAID support.
- Windows, Linux, VMware OS support.
- Host Tools- Windows GUI/CLI, Linux CLI.
- UEFI Support- HII Utility, OBSE.
- Active health monitoring of NVMe M.2 drives requires use of SMART tools.
- Intel VROC NVMe for HPE ProLiant Gen11 will operate in UEFI mode only. For legacy support an additional Tri-Mode controller will be needed.
- For NVMe SSDs only, no PCIe card support.
- ML110 Gen11 supports up to 2x M.2 NVMe drives on onboard slots with Intel Virtual RAID on CPU Standard for RAID 0/1/10 (S0E37A/S0E38AAE).

Essential RAID Controllers

- HPE Smart Array E208e-p SR Gen10 Controller

Tri-mode RAID Controllers

- HPE MR216i-o Gen11 x16 Lanes without Cache OCP SPDM Storage Controller
- HPE MR216i-p Gen11 x16 Lanes without Cache OCP SPDM Storage Controller
- HPE MR408i-o Gen11 x8 Lanes 4GB Cache OCP SPDM Storage Controller
- HPE MR416i-o Gen11 x16 Lanes 8GB Cache OCP SPDM Storage Controller

Maximum Storage

Drive	Capacity	Configuration
Hot Plug LFF SAS HDD	160 TB	8 x20 TB
Hot Plug LFF SAS SSD	61.44 TB	8 x7.68 TB
Hot Plug LFF SATA HDD	160 TB	8 x20 TB
Hot Plug LFF SATA SSD	7.68 TB	8 x960 GB
Hot Plug SFF SAS HDD	38.4 TB	16 x2.4TB
Hot Plug SFF SAS SSD	245.76 TB	16 x15.36 TB
Hot Plug SFF SATA HDD	32 TB	16 x2 TB
Hot Plug SFF SATA SSD	122.88 TB	16 x7.68 TB
Hot Plug NVMe M.2 SSD	480 GB	2 x480 GB (NS204i-u boot option with RAID1 protected)
SATA/NVMe M.2 SSD (Onboard slot)	960 GB/3.84 TB	2 x480 GB/2 x1.92 TB

Graphics

Integrated Video Standard

- Video modes up to 1920 x 1200@60Hz (32 bpp)
- 16MB Video Memory

HPE iLO 6 on system management memory

- 64 MB Flash
- 8 Gbit DDR 4 with ECC protection



Standard Features

Power Supply

- HPE 500W Flex Slot Platinum Hot Plug Low Halogen Power Supply Kit
Notes: Available in 94% Power Efficiency
- HPE 800W Flex Slot Platinum Hot Plug Low Halogen Power Supply Kit
Notes: Available in 94% Power Efficiency
- HPE 1000W Flex Slot Titanium Hot Plug Low Halogen Power Supply Kit
Notes: Available in 96% Power Efficiency
- HPE 1600W Flex Slot Platinum Hot Plug Low Halogen Power Supply Kit
Notes:
 - Available in 94% Power Efficiency.
 - 200-240VAC power input only.

HPE Flexible Slot (Flex Slot) Power Supplies share a common electrical and physical design that allows for hot plug, tool-less installation into HPE ProLiant Gen11 Performance Servers. Flex Slot power supplies are certified for high-efficiency operation and offer multiple power output options, allowing users to "right-size" a power supply for specific server configurations. This flexibility helps to reduce power waste, lower overall energy costs, and avoid "trapped" power capacity in the data center.

All pre-configured servers ship with regional specific power cord with tower server. If a different power cord is required, please check the [ProLiant Power Cables](#) web page.

To review the power requirements for your selected system, please use the [HPE Power Advisor Tool](#).

For information on power specifications and technical content visit [HPE Server power supplies](#)

Interfaces

Serial	Optional, rear
Display Port	1 standard, front
VGA Port	1 VGA Port standard, rear
Network Ports	2 1GbE BCM5720 embedded NIC. Choice of OCP or stand up card
HPE iLO Remote Management Network Port	1 GbE Dedicated, rear
Front iLO Service Port	1 standard, front
USB 3.2 Gen1	4 standard on all models: 1 front, 2 rear, 1 internal
USB 2.0	1 internal



Standard Features

Operating Systems and Virtualization Software Support

- See [HPE Servers Support & Certification Matrices](#)
 - [Microsoft Windows Server](#)
 - [VMware ESXi](#)
 - [Red Hat Enterprise Linux \(RHEL\)](#)
 - [SUSE Linux Enterprise Server \(SLES\)](#)
 - [Canonical Ubuntu](#)
 - [Oracle Linux and Oracle VM](#)
 - [Citrix](#)

Notes: For more information on Hewlett Packard Enterprise Certified and Supported ProLiant Servers for OS and Virtualization Software and latest listing of software drivers available for your server.

<https://www.hpe.com/us/en/servers/server-operating-systems.html>

HPE Server UEFI

Unified Extensible Firmware Interface (UEFI) is an industry standard that provides better manageability and more secured configuration than the legacy ROM while interacting with your server at boot time. HPE ProLiant Gen11 servers have a UEFI Class 3 implementation.

Notes: The UEFI System Utilities tool is analogous to the HPE ROM-Based Setup Utility (RBSU) of legacy BIOS. For more information, please visit <http://www.hpe.com/servers/uefi>.

UEFI enables numerous new capabilities specific to HPE ProLiant servers such as

- Secure Boot and Secure Start enabled for enhanced security
- Operating system specific functionality
- Support for > 2.2 TB (using GPT) boot drives
- USB 3.2 Gen1 Stack
- Embedded UEFI Shell
- Mass Configuration Deployment Tool using iLO RESTful API that is Redfish API Conformant
- PXE boot support for IPv4 IPv6 networks
- Workload Profiles for simple performance optimization

UEFI Boot Mode only

- TPM 2.0 Support
- NVMe Boot Support
- iSCSI Software Initiator Support.
- HTTP/HTTPs Boot support as a PXE alternative.
- Boot support for option cards that only support a UEFI option ROM

Notes: For UEFI Boot Mode, boot environment and OS image installations should be configured properly to support UEFI.

Industry Standard Compliance

- ACPI 6.4 Compliant
- PCIe 5.0 Compliant
- WOL Support
- Microsoft® Logo certifications
- Support for Microsoft Secure Code
- PXE Support
- VGA/Display Port
- USB 3.2 Gen1 Compliant
- USB 2.0 Compliant
- OCP 3.0 SFF NIC Support



Standard Features

- OCP 3.0 SFF Storage Support
- Embedded TPM Support
- Energy Star
- SMBIOS 3.4
- UEFI 2.7
- UEFI Class 3 (Unified Extensible Firmware Interface Forum)
- Redfish API
- IPMI 2.0
- Advanced Encryption Standard (AES)
- Triple Data Encryption Standard (3DES)
- SNMP v3
- TLS 1.2
- DMTF Systems Management Architecture for Server Hardware Command Line Protocol (SMASH CLP)
- DMTF Redfish support for SecureBoot Key Management
- ACPI DSM Drive LED Management
- Memory Page Retire Support
- Retire old VMware Secure Boot Key
- MCTP
- I3C Engine
- APML
- Active Directory v1.0
- ASHRAE A3/A4

Notes: For additional technical, thermal details regarding ambient temperature, humidity, and feature support, please visit <https://www.hpe.com/support/ASHRAEGen11>

Embedded Management

HPE Integrated Lights-Out (HPE iLO)

Monitor your servers for ongoing management, service alerting, reporting and remote management with HPE iLO.

Learn more at <http://www.hpe.com/info/ilo>.

UEFI

Configure and boot your servers securely with industry standard Unified Extensible Firmware Interface (UEFI).

Learn more at <http://www.hpe.com/servers/uefi>

Intelligent Provisioning

Hassle free server and OS provisioning for 1 or more servers with Intelligent Provisioning.

Learn more at <http://www.hpe.com/servers/intelligentprovisioning>

iLO RESTful API

iLO RESTful API is Redfish API conformance and offers simplified server management automation such as configuration and maintenance tasks based on modern industry standards. Learn more at <http://www.hpe.com/info/restfulapi>

HPE GreenLake for Compute Ops Management

HPE is intelligently transforming compute management with an intuitive cloud operating experience through HPE GreenLake cloud platform to streamline and secure operations from edge-to-cloud. Automated key lifecycle tasks, for onboarding, updating, managing, and monitoring HPE servers, brings agility and greater efficiencies to wherever compute devices reside via a unified single browser-based interface. Manage single locations or multiple, distributed sites. Keep tens to thousands of servers secure with batch policy controls and automated updates.



Standard Features

Compute Ops Management is cloud-native software that is continually updated with new services, features, patches, and fixes. The management application resides in the HPE GreenLake cloud platform (access via <https://console.greenlake.hpe.com>) and leverages the HPE GreenLake architecture, security, and unified operations.

Each HPE ProLiant Gen11 rack, tower and micro server will include a 3-year subscription to HPE GreenLake for Compute Ops Management.

For more information, visit the HPE GreenLake for Compute Ops Management QuickSpecs:

<https://www.hpe.com/psnow/doc/a50004263enw>

Server Utilities

Active Health System

The HPE Active Health System (AHS) is an essential component of the iLO management portfolio that provides continuous, proactive health monitoring of HPE servers. Learn more at <http://www.hpe.com/servers/ahs>

Active Health System Viewer

The Active System Health Viewer (AHSV) was deprecated as of March 2022. Users are now recommended to use the InfoSight (<https://www.hpe.com/us/en/solutions/infosight.html>) for Servers Portal for AHS viewing capabilities. In InfoSight for Servers portal, users will also be able to view hardware configuration details, firmware and driver information, warranty and support status of a server, wellness alerts, and create support cases for servers under a valid warranty or support contract.

HPE InfoSight provides the same security assurances as that of AHSV. Furthermore, InfoSight can be used as an AHSV replacement even if customers do not want to share AHSV logs and telemetry data on an ongoing basis.

Smart Update

Keep your servers up to date with the HPE Smart Update solution by using Smart Update Manager (SUM) to optimize the firmware and driver updates of the Service Pack for ProLiant (SPP).

Learn more at <https://www.hpe.com/us/en/servers/smart-update.html>

iLO Amplifier Pack

Designed for large enterprise and service provider environments with hundreds of HPE servers, the iLO Amplifier Pack is a free, downloadable open virtual application (OVA) that delivers the power to discover, inventory and update Gen8, Gen9, Gen10 and Gen11 HPE servers at unmatched speed and scale. Use with an iLO Advanced License to unlock full capabilities.

Learn more at <http://www.hpe.com/servers/iLOamplifierpack>

RESTful Interface Tool

RESTful Interface tool (iLOREST) is a single scripting tool to provision using iLO RESTful API to discover and deploy servers at scale. Learn more at <http://www.hpe.com/info/resttool>

Scripting Tools

Provision one to many servers using your own scripts to discover and deploy with Scripting Tool (STK) for Windows and Linux or Scripting Tools for Windows PowerShell. Learn more at <http://www.hpe.com/servers/powershell>

HPE OneView Standard

HPE OneView is an on premises, multi-generational server monitoring and management solution. HPE OneView Standard can be used for inventory, health monitoring, alerting, and reporting without additional fees. Customers can upgrade their management experience with an HPE OneView Advanced license, all provided by the same tool. Learn more at

<http://www.hpe.com/info/oneview>.



Standard Features

Security

- UEFI Secure Boot and Secure Start support
- Immutable Silicon Root of Trust
- FIPS 140-3 validation (iLO 6 certification in progress)
- Common Criteria certification (iLO 6 certification in progress)
- Configurable for PCI DSS compliance
- Advanced Encryption Standard (AES) and Triple Data Encryption Standard (3DES) on browser
- Support for Commercial National Security Algorithms (CNSA)
- Tamper-free updates – components digitally signed and verified
- Secure Recovery – recover critical firmware to known good state on detection of compromised firmware
- Ability to rollback firmware
- Secure erase of NAND
- TPM (Trusted Platform Module) 2.0
- Front bezel key-lock feature – standard, available in both Tower and Rack models
- Padlock slot, standard
- Kensington Lock slot, standard
- Chassis Intrusion detection option

Warranty

This product is covered by a global limited warranty and supported by HPE Services and a worldwide network of HPE Authorized Channel Partners resellers. Hardware diagnostic support and repair is available for three years from date of purchase. Support for software and initial setup is available for 90 days from date of purchase. Enhancements to warranty services are available through HPE Services operational services or customized service agreements. Hard drives have either a one year or three year warranty; refer to the specific hard drive QuickSpecs for details.

Notes: Server Warranty includes 3-Year Parts, 3-Year Labor, 3-Year Onsite support with next business day response. Warranty repairs may be accomplished through the use of Customer Self Repair (CSR) parts. These parts fall into two categories: 1) Mandatory CSR parts are designed for easy replacement. A travel and labor charge will result when customers decline to replace a Mandatory CSR part; 2) Optional CSR parts are also designed for easy replacement but may involve added complexity. Customers may choose to have Hewlett Packard Enterprise replace Optional CSR parts at no charge. 3) Non CSR parts must be serviced by a trained authorized service engineer. Additional information regarding worldwide limited warranty and technical support is available at: <http://h17007.www1.hp.com/us/en/enterprise/servers/warranty/>



Optional Features

Server Management

HPE iLO Advanced

HPE iLO Advanced licenses offer smart remote functionality without compromise, for all HPE ProLiant servers. The license includes the full integrated remote console, virtual keyboard, video, and mouse (KVM), multi-user collaboration, console record and replay, and GUI-based and scripted virtual media and virtual folders. You can also activate the enhanced security and power management functionality.

HPE OneView Advanced-

HPE OneView brings a new level of automation to infrastructure management by taking a template driven approach to provisioning, updating, and integrating compute, storage, and networking infrastructure. It provides full-featured licenses which can be purchased for managing Gen8, Gen9, Gen10 and Gen11 servers. To learn more visit <http://www.hpe.com/info/oneview>.

HPE InfoSight for Servers

HPE InfoSight for Servers combines the cloud-based machine learning of InfoSight with the health and performance monitoring of Active Health System (AHS) and iLO to optimize performance and predict and prevent problems. The end result is an intelligent environment that modernizes IT operations and enhances the support experience by predicting and preventing the infrastructure issues that lead to application disruptions, wasted IT staff time and missed business opportunities.

Learn more at <https://www.hpe.com/servers/infosight>

HPE Insight Cluster Management Utility (CMU)

HPE Insight Cluster Management Utility is a HyperScale management framework that includes software for the centralized provisioning, management and monitoring of nodes and infrastructure. Learn more at <http://www.hpe.com/info/cmu>.

Accelerator and GPGPU Information

Hewlett Packard Enterprise supports various accelerators on select HPE ProLiant servers to support different workloads. The accelerators enable seamless integration of GPU computing with HPE ProLiant servers for high-performance computing, large data center graphics, deep learning and virtual desktop deployments. These accelerators deliver all of the standard benefits of GPU computing while enabling maximum reliability and tight integration with system monitoring and management tools such as HPE Insight Cluster Management Utility.

Rack and Power Infrastructure

The story may end with servers, but it starts with the foundation that makes compute go – and business grow. We've reinvented our entire portfolio of rack and power products to make IT infrastructure more secure, more practical, and more efficient. In other words, we've created a stronger, smarter, and simpler infrastructure to help you get the most out of your IT equipment. As an industry leader, Hewlett Packard Enterprise is uniquely positioned to address the key concerns of power, cooling, cable management and system access.

HPE G2 Advanced and Enterprise Racks are perfect for the server room or today's modern data center with enhanced airflow and thermal management, flexible cable management, and a 10 year Warranty to support higher density computing.

HPE G2 PDUs offer reliable power in flexible form factors that operate at temperatures up to 60°, include color-coded outlets and load segments and a low-profile design for optimal access to the rack and support for dense rack environments.

HPE Uninterruptible Power Systems are cost-effective power protection for any type workload. Some UPSs include options for remote management and extended runtime modules so your critical dense data center is covered in power outages.

HPE KVM Solutions include a console and switches designed to work with your server and IT equipment reliably. We've got a cost-effective KVM switch for your first rack and multiple connection IP switches with remote management and security capabilities to keep your data center rack up and running.

Learn more about HPE Racks, KVM, PDUs and UPSs at [HPE Rack and Power Infrastructure](#).



Optional Features

One Config Simple (SCE)

SCE is a guided self-service tool to help sales and non-technical people provide customers with initial configurations in 3 to 5 minutes. You may then send the configuration on for configuration help, or use in your existing ordering processes. If you require "custom" rack configuration or configuration for products not available in SCE, please contact Hewlett Packard Enterprise Customer Business Center or an Authorized Partner for assistance.

<https://h22174.www2.hpe.com/SimplifiedConfig/Welcome>



Service and Support

HPE Services

No matter where you are in your digital transformation journey, you can count on HPE Services to deliver the expertise you need when, where and how you need it. From planning to deployment, ongoing operations and beyond, our experts can help you realize your digital ambitions.

<https://www.hpe.com/services>

Consulting Services

No matter where you are in your journey to hybrid cloud, experts can help you map out your next steps. From determining what workloads should live where, to handling governance and compliance, to managing costs, our experts can help you optimize your operations.

<https://www.hpe.com/services/consulting>

HPE Managed Services

HPE runs your IT operations, providing services that monitor, operate, and optimize your infrastructure and applications, delivered consistently and globally to give you unified control and let you focus on innovation.

[HPE Managed Services | HPE](#)

Operational services

Optimize your entire IT environment and drive innovation. Manage day-to-day IT operational tasks while freeing up valuable time and resources. Meet service-level targets and business objectives with features designed to drive better business outcomes.

<https://www.hpe.com/services/operational>

HPE Complete Care Service

HPE Complete Care Service is a modular, edge-to-cloud IT environment service designed to help optimize your entire IT environment and achieve agreed upon IT outcomes and business goals through a personalized experience. All delivered by an assigned team of HPE Services experts. HPE Complete Care Service provides:

- A complete coverage approach -- edge to cloud
- An assigned HPE team
- Modular and fully personalized engagement
- Enhanced Incident Management experience with priority access
- Digitally enabled and AI driven customer experience

<https://www.hpe.com/services/completecure>

HPE Tech Care Service

HPE Tech Care Service is the operational support service experience for HPE products. The service goes beyond traditional support by providing access to product specific experts, an AI driven digital experience, and general technical guidance to not only reduce risk but constantly search for ways to do things better. HPE Tech Care Service delivers a customer-centric, AI driven, and digitally enabled customer experience to move your business forward. HPE Tech Care Service is available in three response levels. Basic, which provides 9x5 business hour availability and a 2-hour response time. Essential which provides a 15-minute response time 24x7 for most enterprise level customers, and Critical which includes a 6-hour repair commitment where available and outage management response for severity 1 incidents.

<https://www.hpe.com/services/techcare>



Service and Support

HPE Lifecycle Services

HPE Lifecycle Services provide a variety of options to help maintain your HPE systems and solutions at all stages of the product lifecycle. A few popular examples include:

- Lifecycle Install and Startup Services: Various levels for physical installation and power on, remote access setup, installation and startup, and enhanced installation services with the operating system.
- HPE Firmware Update Analysis Service: Recommendations for firmware revision levels for selected HPE products, taking into account the relevant revision dependencies within your IT environment.
- HPE Firmware Update Implementation Service: Implementation of firmware updates for selected HPE server, storage, and solution products, taking into account the relevant revision dependencies within your IT environment.
- Implementation assistance services: Highly trained technical service specialists to assist you with a variety of activities, ranging from design, implementation, and platform deployment to consolidation, migration, project management, and onsite technical forums.
- HPE Service Credits: Access to prepaid services for flexibility to choose from a variety of specialized service activities, including assessments, performance maintenance reviews, firmware management, professional services, and operational best practices.

Notes: To review the list of Lifecycle Services available for your product go to:

<https://www.hpe.com/services/lifecycle>

For a list of the most frequently purchased services using service credits, see the [HPE Service Credits Menu](#)

Other Related Services from HPE Services:

HPE Education Services

Training and certification designed for IT and business professionals across all industries. Broad catalogue of course offerings to expand skills and proficiencies in topics ranging from cloud and cybersecurity to AI and DevOps. Create learning paths to expand proficiency in a specific subject. Schedule training in a way that works best for your business with flexible continuous learning options.

<https://www.hpe.com/services/training>

Defective Media Retention

An option available with HPE Complete Care Service and HPE Tech Care Service and applies only to Disk or eligible SSD/Flash Drives replaced by HPE due to malfunction.

Consult your HPE Sales Representative or Authorized Channel Partner of choice for any additional questions and services options.

Parts and Materials

HPE will provide HPE-supported replacement parts and materials necessary to maintain the covered hardware product in operating condition, including parts and materials for available and recommended engineering improvements.

Parts and components that have reached their maximum supported lifetime and/or the maximum usage limitations as set forth in the manufacturer's operating manual, product quick-specs, or the technical product data sheet will not be provided, repaired, or replaced as part of these services.

How to Purchase Services

Services are sold by Hewlett Packard Enterprise and Hewlett Packard Enterprise Authorized Service Partners:

- Services for customers purchasing from HPE or an enterprise reseller are quoted using HPE order configuration tools.
- Customers purchasing from a commercial reseller can find services at <https://ssc.hpe.com/portal/site/ssc/>



Service and Support

AI Powered and Digitally Enabled Support Experience

Achieve faster time to resolution with access to product-specific resources and expertise through a digital and data driven customer experience

Sign into the HPE Support Center experience, featuring streamlined self-serve case creation and management capabilities with inline knowledge recommendations. You will also find personalized task alerts and powerful troubleshooting support through an intelligent virtual agent with seamless transition when needed to a live support agent.

<https://support.hpe.com/hpesc/public/home/signin>

Consume IT On Your Terms

HPE GreenLake edge-to-cloud platform brings the cloud experience directly to your apps and data wherever they are—the edge, colocations, or your data center. It delivers cloud services for on-premises IT infrastructure specifically tailored to your most demanding workloads. With a pay-per-use, scalable, point-and-click self-service experience that is managed for you, HPE GreenLake edge-to-cloud platform accelerates digital transformation in a distributed, edge-to-cloud world.

- Get faster time to market
- Save on TCO, align costs to business
- Scale quickly, meet unpredictable demand
- Simplify IT operations across your data centers and clouds

To learn more about HPE Services, please contact your Hewlett Packard Enterprise sales representative or Hewlett Packard Enterprise Authorized Channel Partner. Contact information for a representative in your area can be found at "Contact HPE"

<https://www.hpe.com/us/en/contact-hpe.html>

For more information

www.hpe.com/services



Pre-configured Models

For the Standard Features shipped in the "Factory Integrated Models", please see the "Configuration Information - Factory Integrated Models" section.

- Pre-configured models ship with the configurations below. Options can be selected from the Core or Additional options section of this QuickSpecs.
- Hewlett Packard Enterprise does not allow factory integration of options into pre-configured models. Any additional options purchased will be shipped separately.
- If you desire a custom configuration please see "Configuration Information - Factory Integrated Models" section of this QuickSpecs.

The pre-configured BTO SKUs are right-sized for use with a single CPU, a single DDR5 DIMM, and a single network controller. The storage subsystem can support either 8SFF or 4LFF drives attached to a storage controller or SATA direct connected to motherboard. The pre-configured power supply unit is sufficient for these reasonable configurations. In cases where the final configuration will be increased by adding more memory, drives, GPUs, or other components please refer to the

HPE Power Advisor Tool for configuration guidance, as your desired configuration may require a second PSU or building the configuration as Configure To Order (CTO) may be best.

Notes: *The maximum memory speed is a function of the memory type, memory configuration, and processor model.

The 4th Generation Intel Xeon® Scalable Processor-based WW BTO SKUs			
	Entry LFF Model	Entry LFF Model	Base SFF Model
SMB Offer – BASE	Performance 1	Performance 1	Performance 2
[SKU Number]	P55533-001 (AMS) P55533-291 (Japan) P55533-371 (APAC) P55533-AA1 (China)	P55534-001 (AMS) P60805-001 (Argentina)	P55535-001 (AMS) P55535-291 (Japan) P55535-371 (APAC) P55535-AA1 (China)
Model Name	HPE ProLiant ML110 Gen11 3408U 1.8GHz 8-core 1P 16GB-R VROC 4LFF 500W RPS Server	HPE ProLiant ML110 Gen11 3408U 1.8GHz 8-core 1P 16GB-R VROC 4LFF 4TB 500W RPS Server	HPE ProLiant ML110 Gen11 3408U 1.8GHz 8-core 1P 32GB- R VROC 8SFF 800W RPS Server
Processor	3408U (8-Core, 1.8 GHz, 125W)		
Number of Processors	One processor		
Memory*	HPE 16GB 1Rx8 PC5-4800B-R Smart Kit		HPE 32GB 2Rx8 PC5-4800B-R Smart Kit
Network Controller	Embedded 2-Port 1GbE BCM5720 networking ports		
Storage Controller	Embedded 8 SATA ports controller with Intel® VROC Software RAID. Notes: Embedded controller can only support SATA drive, additional storage controller is required to support SAS drive.		
Hard Drive	Optional, None ship as standard	Included one 4TB SATA drive	Optional, None ship as standard
Internal Storage	4LFF SAS/SATA Drive Cage		8SFF SAS/SATA Drive Cage
Optical Drive	Optional, None ship as standard Notes: Optical Disk Drive Cable Kit (P57364-B21) is required.		
PCI-Express Slots	PCIe 5.0: 2 slots (x16), upgradable to 4 slots (x16) OCP 3.0 with PCIe Gen 5.0: 1 slot (x16)		
Power Supply	1x HPE 500W Flex Slot Platinum Hot Plug Low Halogen Power Supply Kit Notes: Optional HPE 500W Flex Slot Platinum Hot Plug Low Halogen Power Supply Kit (865408-B21) provides 1+1 power redundancy feature.		1x HPE 800W Flex Slot Platinum Hot Plug Low Halogen Power Supply Kit Notes: Optional HPE 800W Flex Slot Platinum Hot Plug Low Halogen Power Supply Kit (P38995-B21) provides 1+1 power redundancy feature.
Fans	Default with 2 standard fans, non-hot-plug. Optional Redundant Fan Kit (P49984-B21) provides advanced cooling in heavier configurations and redundancy functionality. Notes: Configurations that require fan kits are provided in later sections.		

Pre-configured Models

Management	HPE iLO Standard with Intelligent Provisioning (embedded), HPE OneView Standard (requires download); HPE iLO Advanced and HPE OneView Advanced (require licenses)
Energy Star	Certified
Form Factor	4.5U Tower. Optional Tower-to-Rack conversion kit (P47394-B21) to convert the unit to a 5.5U Rack-mount server.
Warranty	3-year parts, 3-year labor, 3-year onsite support with next business day response.

The 4th Generation Intel Xeon® Scalable Processor-based WW BTO SKUs

	Performance SFF Model	Performance 2 SFF Model
SMB Offer – BASE	Performance 3	Performance 4
[SKU Number]	P55536-001 (AMS) P55536-291 (Japan) P55536-371 (APAC) P55536-AA1 (China)	P55537-001 (AMS) P55537-291 (Japan) P55537-371 (APAC) P55537-AA1 (China)
Model Name	HPE ProLiant ML110 Gen11 4410Y 2.0GHz 12-core 1P 32GB-R VROC 8SFF 800W RPS Server	HPE ProLiant ML110 Gen11 5416S 2.0GHz 16-core 1P 32GB-R VROC 8SFF 800W RPS Server
Processor	4410Y (12-Core, 2.0 GHz, 150W)	5416S (16-Core, 2.0 GHz, 150W)
Number of Processors	One processor	
Memory*	HPE 32GB 2Rx8 PC5-4800B-R Smart Kit	
Network Controller	Embedded 2-Port 1GbE BCM5720 networking ports	
Storage Controller	Embedded 8 SATA ports controller with Intel® VROC Software RAID. Notes: Embedded controller can only support SATA drive, additional storage controller is required to support SAS drive.	
Hard Drive	Optional, None ship as standard	
Internal Storage	8SFF SAS/SATA Drive Cage	
Optical Drive	Optional, None ship as standard Notes: Optical Disk Drive Cable Kit (P57364-B21) is required.	
PCI-Express Slots	PCIe 5.0: 2 slots (x16), upgradable to 4 slots (x16) OCP 3.0 with PCIe Gen 5.0: 1 slot (x16)	
Power Supply	1x HPE 800W Flex Slot Platinum Hot Plug Low Halogen Power Supply Kit Notes: Optional HPE 800W Flex Slot Platinum Hot Plug Low Halogen Power Supply Kit (P38995-B21) provides 1+1 power redundancy feature.	
Fans	Default with 2 standard fans, non-hot-plug. Optional Redundant Fan Kit (P49984-B21) provides advanced cooling in heavier configurations and redundancy functionality. Notes: Configurations that require fan kits are provided in later sections.	
Management	HPE iLO Standard with Intelligent Provisioning (embedded), HPE OneView Standard (requires download); HPE iLO Advanced and HPE OneView Advanced (require licenses)	
Energy Star	Certified	
Form Factor	4.5U Tower. Optional Tower-to-Rack conversion kit (P47394-B21) to convert the unit to a 5.5U Rack-mount server.	
Warranty	3-year parts, 3-year labor, 3-year onsite support with next business day response.	



Pre-configured Models

The 4th Generation Intel Xeon® Scalable Processor-based EMEA BTO SKUs			
	Entry LFF Model	Entry LFF Model	Base SFF Model
SMB Offer – BASE	Performance 1	Performance 1	Performance 2
[SKU Number]	P55637-421(EMEA)	P55638-421(EMEA)	P55639-421(EMEA)
Model Name	HPE ProLiant ML110 Gen11 3408U 1.8GHz 8-core 1P 16GB-R VROC 4LFF 1000W RPS Server	HPE ProLiant ML110 Gen11 3408U 1.8GHz 8-core 1P 16GB-R VROC 4LFF 4TB 1000W RPS Server	HPE ProLiant ML110 Gen11 3408U 1.8GHz 8-core 1P 32GB- R VROC 8SFF 1000W RPS Server
Processor	3408U (8-Core, 1.8 GHz, 125W)		
Number of Processors	One processor		
Memory*	HPE 16GB 1Rx8 PC5-4800B-R Smart Kit		HPE 32GB 2Rx8 PC5-4800B-R Smart Kit
Network Controller	Embedded 2-Port 1GbE BCM5720 networking ports		
Storage Controller	Embedded 8 SATA ports controller with Intel® VROC Software RAID. Notes: Embedded controller can only support SATA drive, additional storage controller is required to support SAS drive.		
Hard Drive	Optional, None ship as standard	Included one 4TB SATA drive	Optional, None ship as standard
Internal Storage	4LFF SAS/SATA Drive Cage		8SFF SAS/SATA Drive Cage
Optical Drive	Optional, None ship as standard Notes: Optical Disk Drive Cable Kit (P57364-B21) is required.		
PCI-Express Slots	PCIe 5.0: 2 slots (x16), upgradable to 4 slots (x16) OCP 3.0 with PCIe Gen 5.0: 1 slot (x16)		
Power Supply	1x HPE 1000W Flex Slot Titanium Hot Plug Power Supply Kit Notes: Optional HPE 1000W Flex Slot Titanium Hot Plug Power Supply Kit (P03178-B21) provides 1+1 power redundancy feature.		
Fans	Default with 2 standard fans, non-hot-plug. Optional Redundant Fan Kit (P49984-B21) provides advanced cooling in heavier configurations and redundancy functionality. Notes: Configurations that require fan kits are provided in later sections.		
Management	HPE iLO Standard with Intelligent Provisioning (embedded), HPE OneView Standard (requires download); HPE iLO Advanced and HPE OneView Advanced (require licenses)		
Energy Star	Certified		
ErP Lot 9	ErP Lot 9 compliant		
Form Factor	4.5U Tower. Optional Tower-to-Rack conversion kit (P47394-B21) to convert the unit to a 5.5U Rack-mount server.		
Warranty	3-year parts, 3-year labor, 3-year onsite support with next business day response.		



Pre-configured Models

The 4th Generation Intel Xeon® Scalable Processor-based EMEA BTO SKUs		
	Performance SFF Model	Performance 2 SFF Model
SMB Offer – BASE	Performance 3	Performance 4
[SKU Number]	P55640-421(EMEA)	P55641-421(EMEA)
Model Name	HPE ProLiant ML110 Gen11 4410Y 2.0GHz 12-core 1P 32GB-R VROC 8SFF 1000W RPS Server	HPE ProLiant ML110 Gen11 5416S 2.0GHz 16-core 1P 32GB-R VROC 8SFF 1000W RPS Server
Processor	4410Y (12-Core, 2.0 GHz, 150W)	5416S (16-Core, 2.0 GHz, 150W)
Number of Processors	One processor	
Memory*	HPE 32GB 2Rx8 PC5-4800B-R Smart Kit	
Network Controller	Embedded 2-Port 1GbE BCM5720 networking ports	
Storage Controller	Embedded 8 SATA ports controller with Intel® VROC Software RAID. Notes: Embedded controller can only support SATA drive, additional storage controller is required to support SAS drive.	
Hard Drive	Optional, None ship as standard	
Internal Storage	8SFF SAS/SATA Drive Cage Kit	
Optical Drive	Optional, None ship as standard Notes: Optical Disk Drive Cable Kit (P57364-B21) is required.	
PCI-Express Slots	PCIe 5.0: 2 slots (x16), upgradable to 4 slots (x16) OCP 3.0 with PCIe Gen 5.0: 1 slot (x16)	
Power Supply	1x HPE 1000W Flex Slot Titanium Hot Plug Power Supply Kit Notes: Optional HPE 1000W Flex Slot Titanium Hot Plug Power Supply Kit (P03178-B21) provides 1+1 power redundancy feature.	
Fans	Default with 2 standard fans, non-hot-plug. Optional Redundant Fan Kit (P49984-B21) provides advanced cooling in heavier configurations and redundancy functionality. Notes: Configurations that require fan kits are provided in later sections.	
Management	HPE iLO Standard with Intelligent Provisioning (embedded), HPE OneView Standard (requires download); HPE iLO Advanced and HPE OneView Advanced (require licenses)	
Energy Star	Certified	
ErP Lot 9	ErP Lot 9 compliant	
Form Factor	4.5U Tower Notes: Optional Tower-to-Rack conversion kit (P47394-B21) to convert the unit to a 5.5U Rack-mount server.	
Warranty	3-year parts, 3-year labor, 3-year onsite support with next business day response.	

European Union Erp Lot 9 2024 Regulation

Beginning on January 1st, 2024, units sold into the European Union (EU), European Economic Area (EEA), the United Kingdom, or Switzerland must include more efficient AC power supplies: 94% for multi-output and 96% for single-output. HPE Flexible Slot power supplies are single-output, and part numbers 865438-B21, P03178-B21, and P44712-B21 are 96% efficient, thus meeting requirements.

HPE is on target to fulfil compliant systems ahead of time and will begin enforcing these requirements in advance to satisfy requests with the current power supplies by the set deadline.



Configuration Information

Smart Templates from HPE

HPE is releasing new Smart Template technology in the One Config Advanced (OCA) configurator. These Templates represent the CTO equivalents of the top-selling BTO configurations. They are intended to provide simple starting points to assist you in easily creating and customizing your desired Server solutions. HPE Servers that have Platform Templates, developed by HPE Product Managers, will have a separate tab in the HPE OCA configurator.

Workload Solutions Templates from HPE

The Workload Solutions Templates build on the Smart Templates technology to easily develop working configurations of the most compelling Workload Solutions. The templates complement the Reference Builds developed by HPE. Workload Solutions templates preconfigure some of the key architecture decisions and make it easier for Sellers to get started and complete a differentiated server solution for your customer’s specific workload.

Mainstream SKUs

HPE launched the Mainstream SKU initiative as a market-driven approach to Demand Steering. It is a simplified portfolio of our top selling options that meet the current and future market trends. HPE has committed to provide a more predictable and faster experience for these options. Mainstream SKUs enjoy higher safety stock levels and have higher fulfillment service levels than non-Mainstream SKUs. Mainstream orders are fulfilled +30% faster than non-Mainstream orders, have fewer shortages and better recovery dates. This platform has Mainstream SKUs in the options portfolio, and is eligible for the improved Mainstream experience. Mainstream SKUs are designated with a Mainstream symbol in our configurators.

Mainstream Configurations

HPE is using the new Smart Templates technology to present Mainstream configurations. All the options in a Mainstream configuration are pre-selected Mainstream SKUs to optimize the performance, predictability and fulfillment experience. Check the Template section in our configurators for eligible Mainstream configurations.

This section lists some of the steps required to configure a Factory Integrated Model. To ensure only valid configurations are ordered, Hewlett Packard Enterprise recommends the use of an HPE approved configurator. Contact your local sales representative for information on configurable product offerings and requirements.

- Factory Integrated Models must start with a CTO Server.
- FIO indicates that this option is only available as a factory integratable option.
- All Factory Integrated Models will be populated with sufficient hard drive blanks based on the number of initial hard drives ordered with the server.
- Some options may not be integrated at the factory. Contact your local sales representative for additional information.

European Union Erp Lot 9 2024 Regulation

Beginning on January 1st, 2024, units sold into the European Union (EU), European Economic Area (EEA), the United Kingdom, or Switzerland must include more efficient AC power supplies: 94% for multi-output and 96% for single-output. HPE Flexible Slot power supplies are single-output, and part numbers 865438-B21, P03178-B21, and P44712-B21 are 96% efficient, thus meeting requirements.

HPE is on target to fulfil compliant systems ahead of time and will begin enforcing these requirements in advance to satisfy requests with the current power supplies by the set deadline.

Step 1: Base Configuration (choose one of the following configurable models)

CTO Server	HPE ML110 Gen11 LFF NHP CTO Server	HPE ML110 Gen11 LFF CTO Server	HPE ML110 Gen11 SFF CTO Server
SKU Number	P51516-B21	P51517-B21	P51518-B21
Processor Sockets	1 Socket available		
Processor	Intel Fourth Generation Xeon® Scalable Processors		
DIMM Slots	16 DIMM slots available		
Storage Controller	Embedded 8 SATA ports controller with Intel® VROC Software RAID Choice of HPE OCP-type RAID (OROC) and/or PCIe Standup controller card (s)		



Configuration Information

PCIe	PCIe 5.0: 2 slots (x16), upgradable to 4 slots (x16) OCP 3.0 with PCIe Gen 5.0: 1 slot (x16)		
Drive Cage - included	4 LFF NHP SATA Drive Cage	4LFF SAS/SATA Drive Cage	8SFF SAS/SATA Drive Cage
Additional drive cages	Optional one 4 LFF NHP SATA Drive Cage kit Notes: Mixing different type Drive Cage with NHP CTO server is not supported.	Optional one 4LFF or 8SFF** SAS/SATA Drive Cage.	Optional one 8SFF SAS/SATA Drive Cage kit
ODD	Optional, Up to 1 Notes: Optical Disk Drive Cable Kit (P57364-B21) is required.		
Half-Height RDX	Optional, Up to 1 Notes: RDX Cable Kit (P53491-B21) is required.		
Megacell Battery	Optional		
Network Controller	Embedded 2-Port 1GbE BCM5720 networking ports. Choice of HPE OCP-type networking adapter and/or PCIe Standup controller card (s).		
Redundant Fan Kit*	2 fans as standard. Optional Redundant Fan Kit (P49984-B21) provides advanced cooling in heavier configurations and redundant functionality.		
Power Supply	HPE Flex Slot Hot Plug Power Supply Kit, up to 2		
Management	HPE iLO with Intelligent Provisioning (standard), iLO Advances and OneView (optional), HPE GreenLake for Compute Ops Management (subscription included)		
USB	5x USB 3.2 Gen1/2.0 ports, Plus front iLO Service Port		
Tower-to-Rack conversion kit	Optional. Tower to Rack kit is not factory integratable option and will be shipped with standalone package.		

Notes:

- * When one of the following scenarios occurs, Redundant Fan Kit (P49984-B21) is required.
Server with the following options installed:
 - o SAS 15K RPM SFF HDD.
 - o SAS4 SFF SSD drives consume power equal to or higher than 15W.
 - o HPE NS204i-u Gen11 NVMe Hot Plug Boot Optimized Storage Device.
 - o GPU and accelerators
 Server is required to continue operating with single fan failure. A flashing amber Health LED will indicate this condition.
Server is required to operate with the A3/A4 extended operating environment with ambient temperature 35°C (95°F) to 45°C (113°F).
- ** Mixed LFF and SFF Drive cages can be supported in one system. Please select the LFF CTO Server (P51517-B21) as the base configuration to start with.
- Refer to **HPE Power Advisor Tool** to review the power requirement for your selected configuration and determine what power supply module(s) to select.



Core Options

Step 2: Choose Required Options (Only one of the following unless otherwise noted)

Step 2a: Choose Processors

Processor Option Kits – Intel Fourth Generation Xeon® Scalable Processors

Note:

- DDR5 memory speed is the maximum memory speed of the processor. Actual memory speed may depend on the quantity and type of DIMMs installed.
- 4800 MT/S maximum memory speed unless otherwise noted.
- 128GB SGX Enclave unless otherwise noted.

Intel Xeon-Gold Processors

Intel Xeon-Gold 6426Y 2.5GHz 16-core 185W Processor for HPE P49598-B21

Intel Xeon-Gold 6421N 1.8GHz 32-core 185W Processor for HPE P49641-B21

Note: 4400 MT/s maximum memory speed.

Intel Xeon-Gold 5418N 1.8GHz 24-core 165W Processor for HPE P49640-B21

Note: 4400 MT/s maximum memory speed.

Intel Xeon-Gold 5412U 2.1GHz 24-core 185W Processor for HPE P49618-B21

Note: 4400 MT/s maximum memory speed.

Intel Xeon-Gold 5418Y 2.0GHz 24-core 185W Processor for HPE P49612-B21

Note: 4400 MT/s maximum memory speed.

Intel Xeon-Gold 5416S 2.0GHz 16-core 150W Processor for HPE P49653-B21

Note: 4000 MT/s maximum memory speed.

Intel Xeon-Gold 5411N 1.9GHz 24-core 165W Processor for HPE P49639-B21

Note: 4400 MT/s maximum memory speed.

Intel Xeon-Gold 5415+ 2.9GHz 8-core 150W Processor for HPE P49597-B21

Note: 4400 MT/s maximum memory speed.

Intel Xeon-Silver Processors

Intel Xeon-Silver 4416+ 2.0GHz 20-core 165W Processor for HPE P49611-B21

Note:

- 4000 MT/s maximum memory speed.
- 64GB SGX Enclave.

Intel Xeon-Silver 4410Y 2.0GHz 12-core 150W Processor for HPE P49610-B21

Note:

- 4000 MT/s maximum memory speed.
- 64GB SGX Enclave.

Intel Xeon-Bronze Processors

Intel Xeon-Bronze 3408U 1.8GHz 8-core 125W Processor for HPE P49617-B21

Note:

- 4000 MT/s maximum memory speed.
- 64GB SGX Enclave.

Step 2b: Choose Memory Options

Please select one or more memory from below.

For new Gen11 memory population rule whitepaper and optimal memory performance guidelines, please go to:

<https://www.hpe.com/docs/memory-population-rules>

For Gen11 memory speed table, please go to: <https://www.hpe.com/docs/memory-speed-table>



Core Options

For memory Reliability, Accessibility, Serviceability (RAS) features whitepaper like Gen10 Fast Fault Tolerance and legacy mirrored memory feature etc. please go to: <https://www.hpe.com/psnow/doc/a50007802enw>

Note:

- The maximum memory speed and capacity is a function of the memory type, memory configuration, and processor model.
- Quantity of memory DIMMs selected per socket must be 1, 2, 4, 6, 8, 12 or 16.
- For additional information, please see the [HPE DDR5 Smart Memory QuickSpecs](#).
- For General Server Memory and Persistent Memory Population Rules and Guidelines, see details here: <http://www.hpe.com/docs/memory-population-rules>
- HPE Server Memory compatibility for a specific server platform may vary or be limited within a server platform depending upon the specific configuration being requested. Because each server environment and requirements can vary, memory compatibility is based not only upon the server family, but may also be affected by the amount and type of additional hardware options installed within a specific server configuration. For this reason, some HPE memory DIMMs may be qualified for an HPE server model or family and yet occasionally not be supported with some configurations within that server family.

Memory – for the Fourth Generation Intel Xeon® Scalable Processors

Description

HPE 16GB (1x16GB) Single Rank x8 DDR5-4800 CAS-40-39-39 EC8 Registered Smart Memory Kit	P43322-B21
HPE 32GB (1x32GB) Dual Rank x8 DDR5-4800 CAS-40-39-39 EC8 Registered Smart Memory Kit	P43328-B21
HPE 64GB (1x64GB) Dual Rank x4 DDR5-4800 CAS-40-39-39 EC8 Registered Smart Memory Kit	P43331-B21

Step 2c: Choose Power Supplies

NotesNote:

- Mixing of 2 different power supplies is NOT supported.
- Selection of two HPE Flex Slot power supplies provide 1+1 power redundancy.
- To review the power requirements for your selected configuration, please use the [HPE Power Advisor Tool](#).

Power Supplies

HPE 500W Flex Slot Platinum Hot Plug Low Halogen Power Supply Kit	865408-B21
---	------------

Note: Support limited to single 125W Processor.

HPE 800W Flex Slot Platinum Hot Plug Low Halogen Power Supply Kit	P38995-B21
HPE 1000W Flex Slot Titanium Hot Plug Power Supply Kit	P03178-B21
HPE 1600W Flex Slot Platinum Hot Plug Low Halogen Power Supply Kit	P38997-B21

Note: Only supports high line voltage (200 VAC to 240 VAC).



Additional Options

Step 3: Choose Additional Factory Integratable Options

Some options may not be integrated at the factory. To ensure only valid configurations are ordered, Hewlett Packard Enterprise recommends the use of an HPE approved configurator. Contact your local sales representative for additional information.

Note: The [User Guide \(UG\)](#) can help to explain the cable routing for each option.

Storage Devices

Storage Controllers

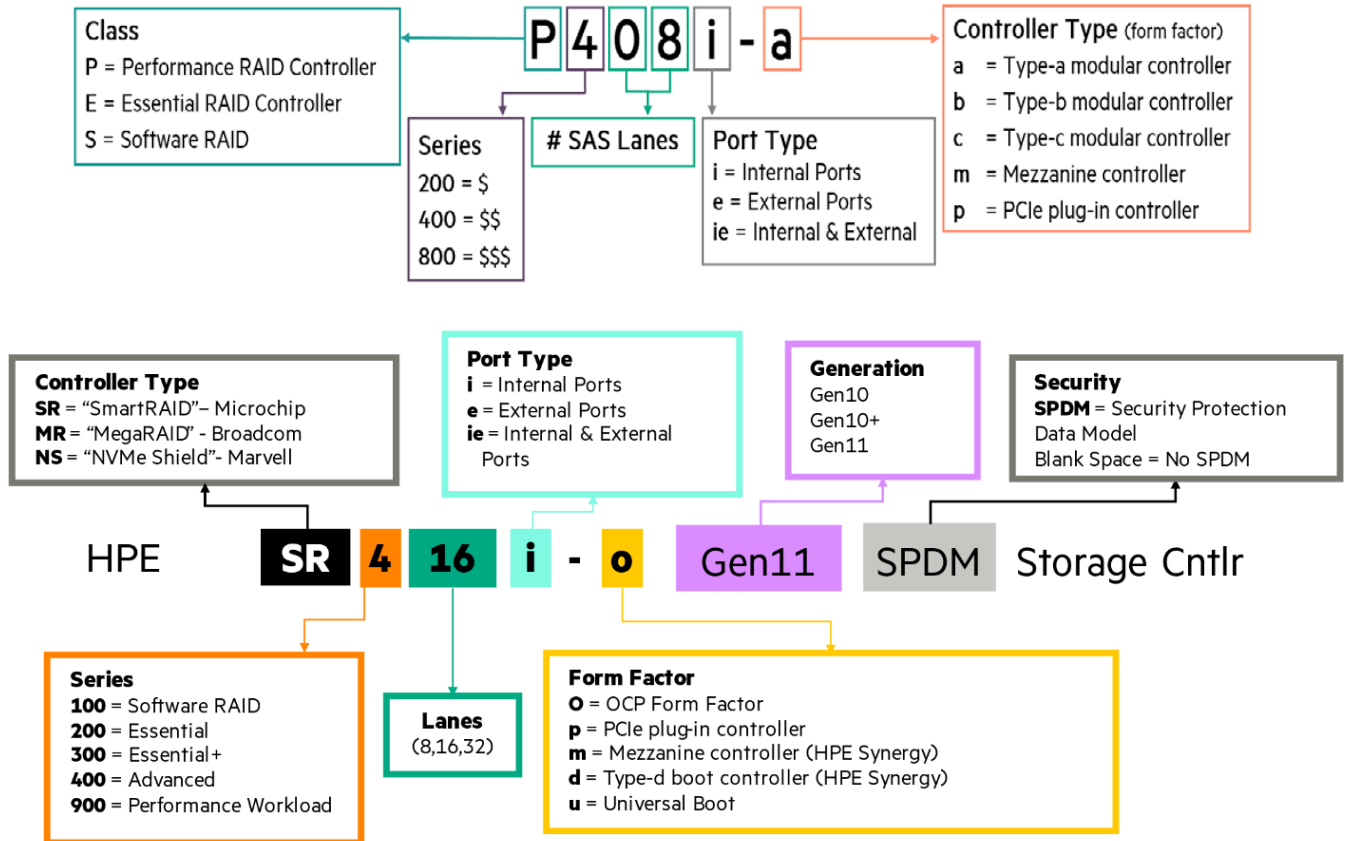

Note:

- When selecting SR RAID controllers for external storage (E208e, 804398-B21) and MR RAID controllers for internal storage (MR216i/MR416i/MR408i) in the order, please be aware these two products use different RAID configuration tools
- Not supporting mixing of MR (MegaRAID) series internal controllers and SR (SmartRAID) series internal Controllers
- OCP-type RAID (OROC) controller is only supported on OCP 1 slot.
- OCP 1 enablement kit is not required for listed OROC controllers below.
- For more information on the HPE Gen11 Storage Controller, please refer to:
[HPE Compute MR Gen11 Controllers Quick Spec](#)
[HPE Compute SR Gen11 Controllers Quick Spec](#)

Essential RAID Controllers

HPE Smart Array E208e-p SR Gen10 (8 External Lanes/No Cache) 12G SAS PCIe Plug-in Controller

804398-B21

Note: This controller supports up to 8 SAS/SATA Drives (external)

For more information on the HPE Smart Array E208i-p SR Gen10 Controller, please refer to the [QuickSpecs](#)

Tri-mode RAID Controllers



Additional Options

HPE MR216i-o Gen11 x16 Lanes without Cache OCP SPDM Storage Controller P47789-B21

Note:

- Does not occupy a PCIe expansion slot.
- This controller supports up to 16 SAS/SATA/NVMe Drives with RAID 0/1/10.

HPE MR216i-p Gen11 x16 Lanes without Cache PCI SPDM Plug-in Storage Controller P47785-B21

Note: This controller supports up to 16 SAS/SATA/NVMe Drives with RAID 0/1/10.

HPE MR408i-o Gen11 x8 Lanes 4GB Cache OCP SPDM Storage Controller P58335-B21

Note:

- Does not occupy a PCIe expansion slot.
- This controller supports up to 8 SAS/SATA/NVMe Drives
- HPE 96W Smart Storage Battery 260mm Cbl (P01367-B21) OR HPE Smart Hybrid Capacitor w/ 260mm Cbl (P02381-B21) must be selected with this controller.

HPE MR416i-o Gen11 x16 Lanes 8GB Cache OCP SPDM Storage Controller P47781-B21

Note:

- Does not occupy a PCIe expansion slot.
- This controller supports up to 16 SAS/SATA/NVMe Drives
- HPE 96W Smart Storage Battery 260mm Cbl (P01367-B21) OR HPE Smart Hybrid Capacitor w/ 260mm Cbl (P02381-B21) must be selected with this controller.

HPE MR416i-p Gen11 x16 Lanes 8GB Cache PCI SPDM Plug-in Storage Controller P47777-B21

Note:

- This controller supports up to 16 SAS/SATA/NVMe Drives
- HPE 96W Smart Storage Battery 260mm Cbl (P01367-B21) OR HPE Smart Hybrid Capacitor w/ 260mm Cbl (P02381-B21) must be selected with this controller.

Smart Storage Battery Cable Kits

HPE 96W Smart Storage Lithium-ion Battery with 260mm Cable Kit P01367-B21

HPE Smart Storage Hybrid Capacitor with 260mm Cable Kit P02381-B21

Note: The two 260mm cable kit can't be selected together.

Software RAID

Intel Virtual RAID on CPU Standard FIO Software for HPE SOE37A

Note:

- Requires UEFI, not supported on Legacy Mode.
- For NVMe SSDs only, no PCIe card support.
- Supports RAID 0/1/10
- ML110 Gen11 supports up to 2x M.2 NVMe drives on onboard slots with Intel Virtual RAID on CPU Standard for RAID 0/1/10 (SOE37A/SOE38AAE).

Intel Virtual RAID on CPU Standard E-RTU for HPE SOE38AAE

Note:

- Requires UEFI, not supported on Legacy Mode.
- For NVMe SSDs only, no PCIe card support.
- Supports RAID 0/1/10
- Similar to Intel Virtual RAID on CPU Standard FIO Software for HPE (SOE37A), but intended for field deployments (BTO).
- ML110 Gen11 supports up to 2x M.2 NVMe drives on onboard slots with Intel Virtual RAID on CPU Standard for RAID 0/1/10 (SOE37A/SOE38AAE).



Additional Options

Drive Cage

HPE ProLiant ML110 Gen11 4LFF Non-hot Plug Drive Cage Kit P53481-B21

Note: Add additional 4 NHP LFF drive cage, allowing for up to 8 NHP LFF SATA drive support (4+4).

HPE ProLiant ML110 Gen11 4LFF Drive Cage Kit P53482-B21

Note: Add additional 4 LFF hot-plug drive cage, allowing for up to 8 LFF SAS/SATA drive support (4+4).

HPE ProLiant ML110 Gen11 8SFF Drive Cage Kit P53483-B21

Note: Add additional 8 SFF hot-plug drive cage, allowing for up to 16 SFF SAS/SATA drive support (8+8).

Storage Controller Cables

HPE ProLiant ML110 Gen11 LFF PCIe Cable Kit P53484-B21

Note: Select this cable kit to support p-type RAID controller with LFF drive cage.

HPE ProLiant ML110 Gen11 SFF OROC Cable Kit P53485-B21

Note: Select this cable kit to support embedded or OCP-type (OROC) controller with SFF drive cage.

HPE ProLiant ML110 Gen11 SFF PCIe Cable Kit P55859-B21

Note: Select this cable kit to support p-type RAID controller with SFF drive cage.

Optical Drive

HPE 9.5mm SATA DVD-ROM Optical Drive 726536-B21

Note: When this ODD selected, ODD cable Kit (P57364-B21) is required.

HPE 9.5mm SATA DVD-RW Optical Drive 726537-B21

Note: When this ODD selected, ODD cable Kit (P57364-B21) is required.

HPE Mobile USB DVD-RW Optical Drive 701498-B21

Optical Drive Accessories

HPE ProLiant ML110 Gen11 Optical Disk Drive Cable Kit P57364-B21

Note: When internal ODD selected, this ODD cable Kit is required.

Riser Cards

HPE ProLiant ML110 Gen11 GPU Riser Kit P53487-B21

Note:

- Add this riser kit to provide additional PCIe Gen5.0 x16 slot on slot 2.
- Additional PCIe adapter is recommended to be installed on slot 2 to get proper thermal condition.
- When GPU selected, this riser kit is required.

HPE ProLiant ML110 Gen11 Second GPU Riser Kit P53488-B21

Note:

- Add this riser kit to provide additional PCIe Gen5.0 x16 slot on slot 3.
- When this Riser Kit is selected, HPE ProLiant ML110 Gen11 GPU Riser Kit (P53487-B21) is required.

HPE Computation and Graphics Accelerators

Note:

- System memory is recommended to be 2 times larger than the memory with accelerator card.
- Redundant Fan Kit (P49984-B21) is required for accelerators.
- System fans may operate at higher speed to maintain optimum system cooling condition with accelerator card.

NVIDIA L4 24GB PCIe Accelerator for HPE S0K89C

- This GPU requires Redundant Fan Kit (P49984-B21), GPU Riser Kit (P53487-B21), L4 GPU Support Kit (P66618-B21) with 25°C maximum inlet temperature.
- The system supports up to 2x L4 GPUs with Second GPU Riser Kit (P53488-B21).
- When this GPU selected, Processor is limited with up to 150W TDP.



Additional Options

HPE ProLiant ML110 Gen11 NVIDIA L4 GPU Support Kit

P66618-B21

Note:

- This support kit supports up to 2x L4 GPUs.
- Memory DIMM blanks within this support kit are required to be installed on all empty memory DIMM slots.

HPE Drives

HPE Hard Disk Drives

Note Mission Critical - 12G SAS - SFF Drives

	SKU
1 HPE 300GB SAS 12G Mission Critical 15K SFF BC 3-year Warranty Multi Vendor HDD	P28028-B21
1 HPE 300GB SAS 12G Mission Critical 10K SFF BC 3-year Warranty Multi Vendor HDD	P40430-B21
1 HPE 600GB SAS 12G Mission Critical 15K SFF BC 3-year Warranty Multi Vendor HDD	P53560-B21
HPE 600GB SAS 12G Mission Critical 10K SFF BC 3-year Warranty Multi Vendor HDD	P53561-B21
1 HPE 900GB SAS 12G Mission Critical 15K SFF BC 3-year Warranty Multi Vendor HDD	P40432-B21
HPE 1.2TB SAS 12G Mission Critical 10K SFF BC 3-year Warranty Multi Vendor HDD	P28586-B21
HPE 1.8TB SAS 12G Mission Critical 10K SFF BC 3-year Warranty 512e Multi Vendor HDD	P53562-B21
HPE 2.4TB SAS 12G Mission Critical 10K SFF BC 3-year Warranty 512e Multi Vendor HDD	P28352-B21

Business Critical - 12G SAS - SFF Drives

HPE 1TB SAS 12G Business Critical 7.2K SFF BC 1-year Warranty HDD	P53563-B21
HPE 2TB SAS 12G Business Critical 7.2K SFF BC 1-year Warranty 512e HDD	P28505-B21

Business Critical - 12G SAS - LFF Drives

HPE 2TB SAS 12G Business Critical 7.2K LFF LP 1-year Warranty Multi Vendor HDD	833926-B21
HPE 4TB SAS 12G Business Critical 7.2K LFF LP 1-year Warranty Multi Vendor HDD	833928-B21
HPE 6TB SAS 12G Business Critical 7.2K LFF LP 1-year Warranty 512e Multi Vendor HDD	861746-B21
HPE 8TB SAS 12G Business Critical 7.2K LFF LP 1-year Warranty 512e Multi Vendor HDD	834031-B21
HPE 10TB SAS 12G Business Critical 7.2K LFF LP 1-year Warranty 512e ISE Multi Vendor HDD	P53556-B21
HPE 12TB SAS 12G Business Critical 7.2K LFF LP 1-year Warranty Helium 512e Multi Vendor HDD	881781-B21
HPE 14TB SAS 12G Business Critical 7.2K LFF LP 1-year Warranty Helium 512e Multi Vendor HDD	P09155-B21
HPE 16TB SAS 12G Business Critical 7.2K LFF LP 1-year Warranty Helium 512e ISE Multi Vendor HDD	P23608-B21
HPE 18TB SAS 12G Business Critical 7.2K LFF LP 1-year Warranty Helium 512e ISE Multi Vendor HDD	P37669-B21
HPE 20TB SAS 12G Business Critical 7.2K LFF LP 1-year Warranty Helium 512e ISE Multi Vendor HDD	P53553-B21

Business Critical - 6G SATA - SFF Drives

HPE 1TB SATA 6G Business Critical 7.2K SFF BC 1-year Warranty HDD	P28610-B21
HPE 2TB SATA 6G Business Critical 7.2K SFF BC 1-year Warranty 512e HDD	P28500-B21

Business Critical - 6G SATA - LFF Drives

HPE 1TB SATA 6G Business Critical 7.2K LFF LP 1-year Warranty Multi Vendor HDD	861686-B21
HPE 1TB SATA 6G Business Critical 7.2K LFF RW 1-year Warranty Multi Vendor HDD	801882-B21
HPE 2TB SATA 6G Business Critical 7.2K LFF LP 1-year Warranty Multi Vendor HDD	861681-B21
HPE 4TB SATA 6G Business Critical 7.2K LFF LP 1-year Warranty Multi Vendor HDD	861683-B21
HPE 4TB SATA 6G Business Critical 7.2K LFF RW 1-year Warranty Multi Vendor HDD	801888-B21
HPE 6TB SATA 6G Business Critical 7.2K LFF LP 1-year Warranty 512e Multi Vendor HDD	861742-B21
HPE 8TB SATA 6G Business Critical 7.2K LFF LP 1-year Warranty 512e Multi Vendor HDD	834028-B21
HPE 10TB SATA 6G Business Critical 7.2K LFF LP 1-year Warranty 512e ISE Multi Vendor HDD	P53557-B21
HPE 12TB SATA 6G Business Critical 7.2K LFF LP 1-year Warranty Helium 512e Multi Vendor HDD	881787-B21
HPE 14TB SATA 6G Business Critical 7.2K LFF LP 1-year Warranty Helium 512e Multi Vendor HDD	P09165-B21
HPE 16TB SATA 6G Business Critical 7.2K LFF LP 1-year Warranty Helium 512e ISE Multi Vendor HDD	P23449-B21
HPE 18TB SATA 6G Business Critical 7.2K LFF LP 1-year Warranty Helium 512e ISE Multi Vendor HDD	P37678-B21
HPE 20TB SATA 6G Business Critical 7.2K LFF LP 1-year Warranty Helium 512e ISE Multi Vendor HDD	P53554-B21

Additional Options

Mission Critical - 12G SAS - SFF SED (Self-Encryption Drive)

HPE 1.2TB SAS 12G Mission Critical 10K SFF BC 3-year Warranty Self-encrypting FIPS HDD	P28622-B21
HPE 2.4TB SAS 12G Mission Critical 10K SFF BC 3-year Warranty 512e Self-encrypting FIPS HDD	P28618-B21

SSD Selection

For SSD selection guidance, please visit <https://ssd.hpe.com/>

Note Read Intensive - 12G/24G SAS - SFF - Solid State Drives

HPE 960GB SAS 12G Read Intensive SFF BC Value SAS Multi Vendor SSD	P40506-B21
HPE 1.92TB SAS 12G Read Intensive SFF BC Value SAS Multi Vendor SSD	P40507-B21
HPE 3.84TB SAS 12G Read Intensive SFF BC Value SAS Multi Vendor SSD	P40508-B21
HPE 7.68TB SAS 12G Read Intensive SFF BC Value SAS Multi Vendor SSD	P40509-B21
HPE 960GB SAS 24G Read Intensive SFF BC Multi Vendor SSD	P49029-B21
HPE 1.92TB SAS 24G Read Intensive SFF BC Multi Vendor SSD	P49031-B21
2 HPE 3.84TB SAS 24G Read Intensive SFF BC Multi Vendor SSD	P49035-B21
2 HPE 7.68TB SAS 24G Read Intensive SFF BC Multi Vendor SSD	P49041-B21
2 HPE 15.36TB SAS 24G Read Intensive SFF BC Multi Vendor SSD	P49045-B21

Mixed Use - 12G/24G SAS - SFF - Solid State Drives

HPE 960GB SAS 12G Mixed Use SFF BC Value SAS Multi Vendor SSD	P40510-B21
HPE 1.92TB SAS 12G Mixed Use SFF BC Value SAS Multi Vendor SSD	P40511-B21
HPE 3.84TB SAS 12G Mixed Use SFF BC Value SAS Multi Vendor SSD	P40512-B21
HPE 800GB SAS 24G Mixed Use SFF BC Multi Vendor SSD	P49047-B21
HPE 1.6TB SAS 24G Mixed Use SFF BC Multi Vendor SSD	P49049-B21
2 HPE 3.2TB SAS 24G Mixed Use SFF BC Multi Vendor SSD	P49053-B21
2 HPE 6.4TB SAS 24G Mixed Use SFF BC Multi Vendor SSD	P49057-B21

Read Intensive - 12G/24G SAS - SFF - SED (Self-Encryption Drive) Solid State Drives

HPE 3.84TB SAS 24G Read Intensive SFF BC Self-encrypting FIPS PM6 SSD	P41398-B21
2 HPE 7.68TB SAS 24G Read Intensive SFF BC Self-encrypting FIPS PM6 SSD	P41399-B21

Mixed Use - 12G/24G SAS - SFF - SED (Self-Encryption Drive) Solid State Drives

HPE 800GB SAS 24G Mixed Use SFF BC Self-encrypting FIPS PM6 SSD	P41400-B21
HPE 1.6TB SAS 24G Mixed Use SFF BC Self-encrypting FIPS PM6 SSD	P41401-B21

Mixed Use -12G/24G SAS - LFF- Solid State Drives

HPE 960GB SAS 12G Mixed Use LFF LPC Value SAS Multi Vendor SSD	P37009-B21
--	------------

Mixed Use - 6G SATA - SFF - Solid State Drives

HPE 480GB SATA 6G Mixed Use SFF BC Multi Vendor SSD	P40502-B21
HPE 960GB SATA 6G Mixed Use SFF BC Multi Vendor SSD	P40503-B21
HPE 1.92TB SATA 6G Mixed Use SFF BC Multi Vendor SSD	P40504-B21
HPE 3.84TB SATA 6G Mixed Use SFF BC Multi Vendor SSD	P40505-B21
HPE 480GB SATA 6G Mixed Use SFF BC PM897 SSD	P44011-B21
HPE 960GB SATA 6G Mixed Use SFF BC PM897 SSD	P44012-B21
HPE 1.92TB SATA 6G Mixed Use SFF BC PM897 SSD	P44013-B21
HPE 1.92TB SATA 6G Mixed Use SFF BC Self-encrypting 5400M SSD	P58248-B21

Read Intensive - 6G SATA - SFF - Solid State Drives

HPE 240GB SATA 6G Read Intensive SFF BC Multi Vendor SSD	P40496-B21
HPE 480GB SATA 6G Read Intensive SFF BC Multi Vendor SSD	P40497-B21
HPE 960GB SATA 6G Read Intensive SFF BC Multi Vendor SSD	P40498-B21
HPE 1.92TB SATA 6G Read Intensive SFF BC Multi Vendor SSD	P40499-B21
HPE 3.84TB SATA 6G Read Intensive SFF BC Multi Vendor SSD	P40500-B21
HPE 7.68TB SATA 6G Read Intensive SFF BC Multi Vendor SSD	P40501-B21

Additional Options

HPE 480GB SATA 6G Read Intensive SFF BC PM893 SSD	P44007-B21
HPE 960GB SATA 6G Read Intensive SFF BC PM893 SSD	P44008-B21
HPE 1.92TB SATA 6G Read Intensive SFF BC PM893 SSD	P44009-B21
HPE 3.84TB SATA 6G Read Intensive SFF BC PM893 SSD	P44010-B21
HPE 1.92TB SATA 6G Read Intensive SFF BC Self-encrypting 5400P SSD	P58240-B21
Very Read Optimized – 6G SATA - SFF – Solid State Drives	
HPE 7.68TB SATA 6G Very Read Optimized SFF BC 5400 SSD	P58228-B21
Read Intensive – 6G SATA - LFF – Solid State Drives	
HPE 960GB SATA 6G Read Intensive LFF LPC Multi Vendor SSD	P47808-B21
Very Read Optimized – 6G SATA - LFF – Solid State Drives	
HPE 7.68TB SATA 6G Very Read Optimized LFF LPC 5400 SSD	P58232-B21
Read Intensive - SATA – M.2 - Solid State Drives	
3 HPE 240GB SATA 6G Read Intensive M.2 Multi Vendor SSD	P47817-B21
3 HPE 480GB SATA 6G Read Intensive M.2 Multi Vendor SSD	P47818-B21
Read Intensive - NVMe – M.2 - Solid State Drives	
3 HPE 480GB NVMe Gen3 Mainstream Performance Read Intensive M.2 Multi Vendor SSD	P40513-B21
3 HPE 960GB NVMe Gen3 Mainstream Performance Read Intensive M.2 Multi Vendor SSD	P40514-B21
3 HPE 1.92TB NVMe Gen3 Mainstream Performance Read Intensive M.2 Multi Vendor SSD	P40515-B21

Note:

- ¹² Redundant Fan Kit (P49984-B21) is required for SAS 15K RPM SFF HDD and SAS4 SFF SSD drives consume power equal to or higher than 15W and system fans may operate at higher speed to maintain optimum system cooling condition.
- ² Support limited to 25°C maximum inlet temperature for SAS4 SFF SSD drives consume power equal to or higher than 15W with Redundant Fan Kit (P49984-B21).
- ³ Mixing of SATA M.2 and NVMe M.2 SSDs is not allowed.

Networking

Note:

- High performance networking cards equal or greater than 100Gb that may cause the fans to operate at higher speeds to maintain optimum system cooling when system at idle status.
- Direct Attach Cable (DAC) for copper environments or fiber transceivers and cables for fiber-optic environments must be purchased separately. Please see the related NIC QuickSpecs for Technical Specifications and additional information: <https://h20195.www2.hpe.com/v2/getpdf.aspx/A00002507ENW>.

PCIe Adapters

1 Gigabit Ethernet adapters

Broadcom BCM5719 Ethernet 1Gb 4-port BASE-T Adapter for HPE	P51178-B21
Intel I350-T4 Ethernet 1Gb 4-port BASE-T Adapter for HPE	P21106-B21

10 Gigabit Ethernet adapters

Broadcom BCM57416 Ethernet 10Gb 2-port BASE-T Adapter for HPE	P26253-B21
Broadcom BCM57412 Ethernet 10Gb 2-port SFP+ Adapter for HPE	P26259-B21

10/25 Gigabit Ethernet adapters

Broadcom BCM57414 Ethernet 10/25Gb 2-port SFP28 Adapter for HPE	P26262-B21
Intel E810-XXVDA2 Ethernet 10/25Gb 2-port SFP28 Adapter for HPE	P08443-B21
Mellanox MCX631102AS-ADAT Ethernet 10/25Gb 2-port SFP28 Adapter for HPE	P42044-B21
Intel E810-XXVDA4 Ethernet 10/25Gb 4-port SFP28 Adapter for HPE	P08458-B21



Additional Options

100 Gigabit Ethernet adapters

Intel E810-CQDA2 Ethernet 100Gb 2-port QSFP28 Adapter for HPE P21112-B21

OCP Adapter

1 Gigabit Ethernet OCP adapters

Broadcom BCM5719 Ethernet 1Gb 4-port BASE-T OCP3 Adapter for HPE P51181-B21

Intel I350-T4 Ethernet 1Gb 4-port BASE-T OCP3 Adapter for HPE P08449-B21

10 Gigabit Ethernet OCP Adapters

Broadcom BCM57412 Ethernet 10Gb 2-port SFP+ OCP3 Adapter for HPE P26256-B21

Broadcom BCM57416 Ethernet 10Gb 2-port BASE-T OCP3 Adapter for HPE P10097-B21

10/25 Gigabit Ethernet OCP adapters

Intel E810-XXVDA2 Ethernet 10/25Gb 2-port SFP28 OCP3 Adapter for HPE P10106-B21

Mellanox MCX631432AS-ADAI Ethernet 10/25Gb 2-port SFP28 OCP3 Adapter for HPE P42041-B21

Broadcom BCM57414 Ethernet 10/25Gb 2-port SFP28 OCP3 Adapter for HPE P10115-B21

Broadcom BCM57504 Ethernet 10/25Gb 4-port SFP28 OCP3 Adapter for HPE P26269-B21

100 Gigabit Ethernet adapters

Intel E810-CQDA2 Ethernet 100Gb 2-port QSFP28 OCP3 Adapter for HPE P22767-B21

OS Boot Device

HPE NS204i-u Gen11 NVMe Hot Plug Boot Optimized Storage Device P48183-B21

Note:

- When NS204i-u is selected, Redundant Fan Kit (P49984-B21) is required.
- When NS204i-u is selected, embedded controller for SATA drive is not available.
- NS204i-u is not supported with NHP CTO server.
- System fans may operate at higher speed to maintain optimum system cooling condition while NS204i-u is installed.

HPE ProLiant ML110 Gen11 NS204i-u Enablement Kit P61742-B21

Note: When NS204i-u is selected, this Enablement Kit is required.

Accessories

HPE ProLiant ML110 Gen11 Serial Port Cable Kit P53489-B21

Security Options

HPE ProLiant ML350/ML110 Gen11 Intrusion Cable Kit P47226-B21

Power and Cooling

Cooling Options

HPE ProLiant ML110 Gen11 Redundant Fan Kit P49984-B21

Note:

When one of the following scenarios occurs, Redundant Fan Kit (P49984-B21) is required.

- Server with the following options installed:
 - o SAS 15K RPM SFF HDD.
 - o SAS4 SFF SSD drives consume power equal to or higher than 15W.
 - o HPE NS204i-u Gen11 NVMe Hot Plug Boot Optimized Storage Device.
 - o GPU and accelerators
- Server is required to continue operating with single fan failure. A flashing amber Health LED will indicate this condition.
- Server is required to operate with the A3/A4 extended operating environment with ambient temperature 35°C (95°F) to 45°C (113°F).



Additional Options

Power Suppliers

HPE Flexible Slot (Flex Slot) Power Supplies share a common electrical and physical design that allows for hot plug, tool-less installation into HPE ProLiant Servers. Flex Slot power supplies are certified for high-efficiency operation and offer multiple power output options, allowing users to "right-size" a power supply for specific server configurations. This flexibility helps to reduce power waste, lower overall energy costs, and avoid "trapped" power capacity in the data center.

Note:

- Prior to making a power supply selection it is highly recommended that the [HPE Power Advisor Tool](#) is run to determine the right size power supply for your server configuration.
- Visit [HPE Power Cords and Cables](#) for a full list of optional power cords.
- Flex Slot Platinum power supplies support power efficiency of up to 94% and include a standard C-14 power inlet connector.
- Flex Slot Titanium power supplies support power efficiency of up to 96% and include a standard C-14 power inlet connector.

HPE 500W Flex Slot Platinum Hot Plug Low Halogen Power Supply Kit	865408-B21
HPE 800W Flex Slot Platinum Hot Plug Low Halogen Power Supply Kit	P38995-B21
HPE 1000W Flex Slot Titanium Hot Plug Power Supply Kit	P03178-B21
HPE 1600W Flex Slot Platinum Hot Plug Low Halogen Power Supply Kit	P38997-B21

Note: Only supports high line voltage (200 VAC to 240 VAC).

Storage Backup

For the complete range of tape drives, autoloaders, libraries and media see:

<https://www.hpe.com/us/en/storage/storeever-tape-storage.html>.

For hardware and software compatibility of Hewlett Packard Enterprise tape backup products

<http://www.hpe.com/storage/BURACompatibility>.

Note:

- When internal RDX docking station ordered, HPE ProLiant ML110 Gen11 RDX Cable Kit (P53491-B21) is required.
- Support up to one RDX internal docking station in media bay.
- Required to change Thermal Configuration to Increased Cooling mode in BIOS/Platform Configuration (RBSU) menu and system fans may operate at higher speed.

HPE Tape Drives

HPE StoreEver LTO-8 Ultrium 30750 External Tape Drive	BC023A
HPE StoreEver LTO-9 Ultrium 45000 External Tape Drive	BC042A
HPE StoreEver LTO-7 Ultrium 15000 External Tape Drive	BB874A

HPE Tape Drives Cartridge

HPE LTO-6 Ultrium 6.25TB RW Data Cartridge	C7976A
HPE LTO-7 Ultrium 15TB RW Data Cartridge	C7977A
HPE LTO-8 Ultrium 30TB RW Data Cartridge	Q2078A
HPE LTO-9 Ultrium 45TB RW Data Cartridge	Q2079A

HPE Tape Backup Products

HPE StoreEver Mini-SAS High Density to 4-lane Mini-SAS External Fanout 2m Cable	K2R09A
HPE StoreEver Mini-SAS High Density to 4-lane Mini-SAS External Fanout 4m Cable	K2R10A

HPE RDX Products

HPE RDX External Docking Station	C8S07B
HPE RDX Internal Docking Station	C8S06A
HPE RDX 4TB Removable Disk Cartridge	Q2048A
HPE RDX 2TB Removable Disk Cartridge	Q2046A



Additional Options

HPE RDX 1TB Removable Disk Cartridge Q2044A

HPE RDX 500GB Removable Disk Cartridge Q2042A

Internal RDX Support Kit

HPE ProLiant ML110 Gen11 RDX Cable Kit P53491-B21

Note: Supporting cables to add internal RDX device for data backup or archiving.

HPE Racks

- Please see the [HPE Advanced Series Racks QuickSpecs](#) for information on additional racks options and rack specifications.
- Please see the [HPE Enterprise Series Racks QuickSpecs](#) for information on additional racks options and rack specifications.
- Please see the [HPE Standard Series Racks QuickSpecs](#) for information on additional racks options and rack specifications.

HPE Power Distribution Units (PDUs)

- Please see the [HPE Basic Power Distribution Units \(PDU\) QuickSpecs](#) for information on these products and their specifications.
- Please see the [HPE Metered Power Distribution Units \(PDU\) QuickSpecs](#) for information on these products and their specifications.
- Please see the [HPE Intelligent Power Distribution Unit \(PDU\) QuickSpecs](#) for information on these products and their specifications.
- Please see the [HPE Metered and Switched Power Distribution Units \(PDU\) QuickSpecs](#) for information on these products and their specifications.

HPE Uninterruptible Power Systems (UPS)

- To learn more, please visit the [HPE Uninterruptible Power Systems \(UPS\) web page](#).
- Please see the [HPE DirectFlow Three Phase Uninterruptible Power System QuickSpecs](#) for information on these products and their specifications.
- Please see the [HPE Line Interactive Single Phase UPS QuickSpecs](#) for information on these products and their specifications.

HPE T750 Gen5 NA/JP UPS with Management Card Slot Q1F47A

HPE T750 Gen5 INTL UPS with Management Card Slot Q1F48A

HPE T1000 Gen5 NA/JP UPS with Management Card Slot Q1F49A

HPE T1000 Gen5 INTL UPS with Management Card Slot Q1F50A

HPE T1500 Gen5 NA/JP UPS with Management Card Slot Q1F51A

HPE T1500 Gen5 INTL UPS with Management Card Slot Q1F52A

HPE Rack Options

Please see the [HPE KVM Switches web page](#) for information on these products and their specifications.

Rail Kits

HPE ProLiant ML350/ML110 Gen11 T/R Conversion Kit P47394-B21

Note: Easy install rack rail tray which takes up 1U height in a standard rack facility with CMA can only be shipped as standalone option package. This kit is supported in both ML350 and ML110 Gen11 for tower to rack conversion.



Additional Options

HPE GreenLake for Compute Ops Management

Base SKU

HPE GreenLake for Compute Ops Management Enhanced 3-year Upfront ProLiant SaaS R7A11AAE

Upgrade SKU

HPE GreenLake for Compute Ops Management Enhanced 5-year Upfront ProLiant SaaS R7A12AAE

For more information, visit the HPE GreenLake for Compute Ops Management QuickSpecs:

<https://www.hpe.com/psnow/doc/a50004263enw>

Supported Servers – CTO only. No OEM. – Complete list can be found here: Latest Supported Server List:

<https://www.hpe.com/info/com-supported-servers>

Converged Infrastructure Management Software

HPE OneView

HPE OneView including 3yr 24x7 Support Flexible Quantity E-LTU E5Y35AAE

HPE OneView w/o iLO including 3yr 24x7 Support Flexible Quantity E-LTU P8B26AAE

Insight Software

HPE iLO Advanced

HPE iLO Advanced Electronic License with 1yr Support on iLO Licensed Features E6U59ABE

HPE iLO Advanced Electronic License with 3yr Support on iLO Licensed Features E6U64ABE

HPE iLO Advanced 1-server License with 3yr Support on iLO Licensed Features BD505A

HPE iLO Advanced Flexible Quantity License with 3yr Support on iLO Licensed Features BD506A

HPE iLO Advanced AKA Tracking License with 3yr Support on iLO Licensed Features BD507A

HPE iLO Advanced 1-server License with 1yr Support on iLO Licensed Features 512485-B21

HPE iLO Advanced Flexible Quantity License with 1yr Support on iLO Licensed Features 512486-B21

HPE iLO Advanced AKA Tracking License with 1yr Support on iLO Licensed Features 512487-B21

Factory Configuration Settings

HPE iLO Common Password FIO Setting P08040-B21

Note:

- Replaces iLO default randomized password by an HPE defined common password. HPE highly recommends changing this password immediately after the initial onboarding process.
 - Customers who want to choose their own custom iLO default password should use the HPE Factory Express Integration Services.
-



Memory

Memory Population guidelines

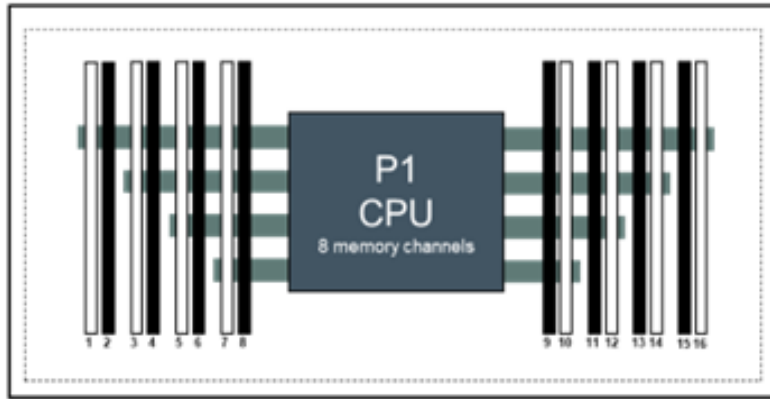

HPE ML110 Gen11 Server (Front of server)

Note: 2 Slots per channel

HPE ProLiant ML110 Gen11 Servers 16 slots per CPU DIMM population order

1 DIMM										10										
2 DIMMs²			3							10										
4 DIMMs²			3				7				10					14				
6 DIMMs			3	5		7					10				14	16				
8 DIMMs^{1,2}	1			3	5		7					10	12				14	16		
12 DIMMs	1	2	3				5	6	7				10	11	12			14	15	16
16 DIMMs^{1,2}	1	2	3	4	5	6	7	8	9	10	11	12	13	14	15	16				

Note:

- ¹ Support SGX (Software Guard Extensions)
- ² Support Hemi (hemisphere mode)



Memory

General Memory Population Rules and Guidelines:

- Install DIMMs only if the corresponding processor is installed. If only one processor is installed in a 2-processor system, only half of the DIMM slots are available to populate.
- If a memory channel consists of more than one DIMM slot, the white DIMM slot is located furthest from the CPU. White DIMM slots denote the first slot to be populated in a channel. For one DIMM per channel (DPC), populate white DIMM slots only
- Rank mixing is not allowed on a channel except for 1 rank + 2 rank combination when all 16 DIMMs for a Processor socket is populated. (2 rank in white slot, 1 rank in block slot),
- No x4 mixing with x8 across a socket.
- If multiple CPUs are populated, split the HPE Smart Memory DIMMs evenly across the CPUs and follow the corresponding CPU rules when populating DIMMs.
- To maximize performance, it is recommended to balance the total memory capacity across all installed processors and load the channels similarly whenever possible.
- If the number of DIMMs does not spread evenly across the CPUs, populate as close to evenly as possible.
- Avoid creating an unbalanced configuration for any CPU.
- The maximum memory capacity is a function of the number of DIMM slots on the platform—the largest DIMM capacity qualified on the platform and the number and model of qualified processors installed on the platform.
- Do not mix HPE Smart Memory RDIMMs and HPE Smart Memory LRDIMMs in the same system.
- Rank mixing is not allowed on a channel except for 1 rank + 2 rank combination (2 rank in white slot, 1 rank in block slot), when all 16 DIMMs for a Processor socket is populated.
- The 256 GB 8R 3DS RDIMM can be mixed with 128 GB 4R 3DS RDIMM ONLY in 16 DIMMs populated. 256 GB 8R 3DS RDIMM needs to be in white slot while 128 GB 4R 3DS RDIMM needs to be in black slot.
- The maximum memory speed is a function of the memory type, memory configuration, and processor model.
- DIMMs of different speeds may be mixed in any order; however, the server will select the lowest common speed among all of the DIMMs on all of the CPUs.
- HPE Smart Memory DIMMs and HPE NVDIMM-Ns from previous generation servers are not compatible with the current generation. Certain HPE Smart Memory features such as memory authentication and enhanced performance may not be supported.
- There are no performance implications for mixing sets of different capacity DIMMs at the same operating speed. For example, latency and throughput will not be negatively impacted by installing an equal number of 32 GB 1rank x4 DDR5-4800 DIMMs (in block slot) and 64 GB 2rank x4 DDR5-4800 DIMMs (in white slot).
- Take each DIMM type and create a configuration as if it were a homogeneous configuration.
- For details on the HPE Server Memory Options Population Rules, visit: <http://www.hpe.com/docs/memory-population-rules>.
- For additional information, please see the [HPE DDR5 Smart Memory QuickSpecs](#).

Note: The maximum memory speed is a function of the memory type, memory configuration, and processor model.

For details on the HPE Server Memory speed, visit: <https://www.hpe.com/docs/memory-speed-table>.



Storage

**8 NHP LFF drive model**

Tower – shown with tower feet.

- 2 x 4LFF NHP SATA Drive Cage Kit in Box 1/2.
- Internal RDX Docking station.

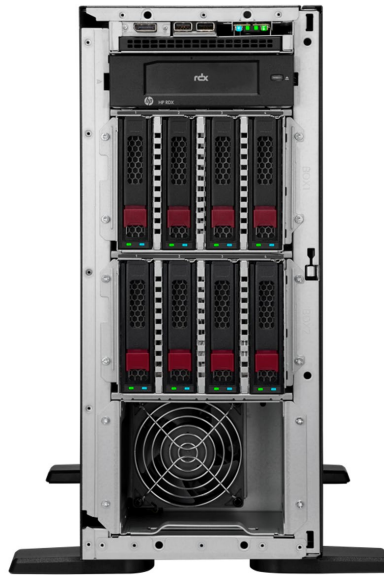
**8 LFF hot-plug drive model**

Tower – shown with tower feet.

- 2 x 4LFF SAS/SATA hot-pluggable Drive Cage Kit in Box 1/2.
- Internal RDX Docking station.

**16 SFF hot-plug drive model**

Tower – shown with tower feet.

- 2 x 8SFF SAS/SATA hot-pluggable Drive Cage Kit in Box 1/2.
- Internal RDX Docking station.



Technical Specifications

System Unit

Dimensions

- **Tower**
46.2 (H) x 58.7 (D) x 19.5 (W) cm
18.19 (H) x 23.1 (D) x 7.68 (W) in
- **Rack – System only**
19.5 (H/4.5U) x 58.7 (D) x 44.5 (W) cm
7.68 (H) x 23.1 (D) x 17.5 (W) in
- **Tower-to-Rack Conversion Kit (1U)**
4.445 (H/1U) x 69.2 (D/without CMA. Depth with CMA: 83.5) x 45.2 (W) cm
1.75 (H/1U) x 27.23 (D/without CMA. Depth with CMA: 32.89) x 17.795 (W) in

Weight (approximate)

- **20.1 kg (44.31 lb)**
SFF Minimum:
1x 8SFF cage with 1x SFF HDD and 7x SFF HDD blanks, 1x Drive Cage blank, 1x Media Bay blanks, 1x DVD bay blank, 1x processor including standard heatsink, 1x DIMM, 1x power supply (plus blank), 1x x8 HHHL card(Max. 166g), 1x OCP blanks, 1x GPU Riser Cage blank, Cables for the above.
- **30.3 kg (66.8 lb)**
SFF Maximum:
16x SFF HDDs with 2x SFF Drive cages, 1x DVD device, 1x processor including standard heatsink, 16x DIMMs, 2x power supply, 1x GPU riser cage, 1x Megacell, 1x OCP, 2x Single Width x16 GPU card, 2x x8 HHHL card (Max. 166g), Cables for the above.
- **20.4 kg (44.97 lb)**
LFF Minimum:
1x 4LFF cage with 1x LFF HDD and 3x HDD blanks, 1x Drive Cage blank, 1x Media Bay blanks, 1x DVD bay blank, 1x processor including standard heatsink, 1x DIMM, 1x power supply (plus blank), 1x x8 HHHL card (Max. 166g), 1x Megacell, 1x OCP blanks, 1x GPU Riser Cage blank, Cables for the above.
- **33.2 kg (73.19 lb)**
LFF Maximum:
8x LFF HDDs with 2x LFF Drive Cage, 1x DVD device, 1x processor including standard heatsink, 16x DIMMs, 2x power supply, 1x GPU Riser Cage, 1x Megacell, 1x OCP, 2x Single Width x16 GPU card, 2x x8 HHHL card(Max. 166g), 1x NS204i-u, Cables for the above.

Input Requirements (per power supply)

Rated Line Voltage

- 100 to 120 VAC
- 200 to 240 VAC

BTU Rating

Maximum

- For 500W Power Supply: 1902 BTU/hr (at 100 VAC), 1840 BTU/hr (at 200 VAC), 1832 BTU/hr (at 240 VAC)
 - For 800W Power Supply: 3067 BTU/hr (at 100 VAC), 2958 BTU/hr (at 200 VAC), 2949 BTU/hr (at 240 VAC)
 - For 1000W Power Supply: 3741 BTU/hr (at 100 VAC), 3596 BTU/hr (at 200 VAC), 3582 BTU/hr (at 240 VAC)
 - For 1600W Power Supply: 5918 BTU/hr (at 200 VAC), 5884 BTU/hr (at 240 VAC)
-



Technical Specifications

Power Supply Output (per power supply)

Rated Steady-State Power

- For 1600W (Titanium) Power Supply: 1600W (at 240 VAC), 1600W (at 240 VDC) for China only
- For 1000W (Titanium) Power Supply: 1000W (at 100 VAC), 1000W (at 240 VAC)
- For 800W (Platinum) Power Supply: 800W (at 100 VAC), 800W (at 240 VAC), 800W (at 240 VDC) input for China only
- For 500W (Platinum) Power Supply: 500W (at 100 VAC), 500W (at 240 VAC), 500W (at 240 VDC) input for China only

Maximum Peak Power

- For 1600W (Titanium) Power Supply: 1600W (at 240 VAC), 1600W (at 240 VDC) for China only
 - For 1000W (Titanium) Power Supply: 1000W (at 100 VAC), 1000W (at 240 VAC)
 - For 800W (Platinum) Power Supply: 800W (at 100 VAC), 800W (at 240 VAC), 800W (at 240 VDC) input for China only
 - For 500W (Platinum) Power Supply: 500W (at 100 VAC), 500W (at 240 VAC), 500W (at 240 VDC) input for China only
-

System Inlet Temperature

- **Standard Operating Temperature**

10° to 35°C (50° to 95°F) at sea level with an altitude derating of 1.0°C per every 305 m (1.8°F per every 1000 ft) above sea level to a maximum of 3050 m (10,000 ft), no direct sustained sunlight. Maximum rate of change is 20°C/hr (36°F/hr). The upper limit and rate of change may be limited by the type and number of options installed. System performance during standard operating support may be reduced if operating with a fan fault or above 30°C (86°F).

- **Extended Ambient Operating Temperature**

For approved hardware configurations, the supported system inlet range is extended to be: 5° to 10°C (41° to 50°F) and 35° to 40°C (95° to 104°F) at sea level with an altitude derating of 1.0°C per every 175 m (1.8°F per every 574 ft) above 900 m (2953 ft) to a maximum of 3050 m (10,000 ft). The approved hardware configurations for this system are listed at the URL: <https://www.hpe.com/support/ASHRAEGen11>

For approved hardware configurations, the supported system inlet range is extended to be: 40° to 45°C (104° to 113°F) at sea level with an altitude derating of 1.0°C per every 125 m (1.8°F per every 410 ft) above 900 m (2953 ft) to a maximum of 3050 m (10,000 ft). The approved hardware configurations for this system are listed at the URL: <https://www.hpe.com/support/ASHRAEGen11>

System performance may be reduced if operating in the extended ambient operating range or with a fan fault.

- **Non-operating**

-30° to 60°C (-22° to 140°F). Maximum rate of change is 20°C/hr (36°F/hr).

Relative Humidity (non-condensing)

- **Operating**

8% to 90% - Relative humidity (Rh), 28°C maximum wet bulb temperature, non-condensing.

- **Non-operating**

5 to 95% relative humidity (Rh), 38.7°C (101.7°F) maximum wet bulb temperature, non-condensing.

Altitude

- **Operating**

3050 m (10,000 ft). This value may be limited by the type and number of options installed. Maximum allowable altitude change rate is 457 m/min (1500 ft/min).

- **Non-operating**

9144 m (30,000 ft). Maximum allowable altitude change rate is 457 m/min (1500 ft/min).



Technical Specifications

Emission Classification (EMC) Regulatory Information

To view the regulatory information for your product, view the Safety and Compliance Information for Server, Storage, Power, Networking, and Rack Products, available at the Hewlett Packard Enterprise Support Center:

https://support.hpe.com/hpsc/public/docDisplay?docLocale=en_US&docId=c03471072

Environment-friendly Products and Approach End-of-life Management and Recycling

Hewlett Packard Enterprise offers **end-of-life product return, trade-in, and recycling programs**, in many geographic areas, for our products. Products returned to Hewlett Packard Enterprise will be recycled, recovered or disposed of in a responsible manner.

The EU WEEE directive (2002/95/EC) requires manufacturers to provide treatment information for each product type for use by treatment facilities. This information (product disassembly instructions) is posted on the Hewlett Packard Enterprise web site. These instructions may be used by recyclers and other WEEE treatment facilities as well as Hewlett Packard Enterprise OEM customers who integrate and re-sell Hewlett Packard Enterprise equipment.

Acoustic Noise

Listed are the declared mean A-Weighted sound power levels (LwAm), declared average bystander position A-Weighted sound pressure levels (LpAm) and the statistical adder for verification, Kv, is a quantity to be added to the declared mean A-weighted sound power

level, LwA,m when the product is operating in a 23°C ambient environment. Noise emissions were measured in accordance with ISO 7779 (ECMA 74) and declared in accordance with ISO 9296 (ECMA 109). The listed sound levels apply to standard shipping configurations. Additional options may result in increased sound levels. Please have your HPE representative provide information from the HPE EMESC website for further technical details regarding the configurations listed below.

Test Case	Entry LFF Model	Entry LFF Model	Base SFF Model	Performance SFF Model	Performance 2 SFF Model
Idle					
LwA,m	3.7 B	3.7 B	3.7 B	3.7 B	3.7 B
LpAm	22 dBA	22 dBA	22 dBA	22 dBA	22 dBA
Kv	0.4 B	0.4 B	0.4 B	0.4 B	0.4 B
Operating					
LwA,m	4.2 B	4.2 B	4.3 B	4.0 B	5.1 B
LpAm	28 dBA	28 dBA	28 dBA	25 dBA	33 dBA
Kv	0.4 B	0.4 B	0.4 B	0.4 B	0.4 B

Note:

- The declared mean A-weighted sound power level, LWA,m, is computed as the arithmetic average of the measured.
- A-weighted sound power levels for a randomly selected sample, rounded to the nearest 0,1 B.
- The declared mean A-weighted emission sound pressure level, LpA,m, is computed as the arithmetic average of the measured A-weighted emission sound pressure levels at the bystander positions for a randomly selected sample, rounded to the nearest 1 dB.
- The statistical adder for verification, Kv, is a quantity to be added to the declared mean A-weighted sound power level, LWA,m, such that there will be a 95 % probability of acceptance, when using the verification procedures of ISO 9296, if no more than 6,5 % of the batch of new equipment, has A-weighted sound power levels greater than (LWA,m + Kv).
- The quantity, LWA,c (formerly called LwA,m), can be computed from the sum of LWA,m and Kv.
- All measurements made to conform to ISO 7779 / ECMA-74 and declared to conform to ISO 9296 / ECMA-109.
- B, dB, abbreviations for bels and decibels, respectively, where 1 B = 10 dB.
- The results in this declaration apply only to the model numbers listed above when operating and tested according to the indicated modes and standards. A system with additional configuration components or increased operating functionality may increase the noise emission values.
- System under abnormal conditions may increase the noise level, persons in the vicinity of the product [cabinet] for extended periods of time should consider wearing hearing protection or using other means to reduce noise exposure.

Summary of Changes

Date	Version History	Action	Description of Change
06-Nov-2023	Version 6	Changed	Optimize Configuration content, add new options support.
05-Sep-2023	Version 5	Changed	Optimize Configuration content, add new Lot 9 required statements and update options sections.
17-Jul-2023	Version 4	Changed	Configuration Information section was updated
10-Jul-2023	Version 3	Changed	Standard Features, Pre-Configured Models, Configuration Information and Core Options sections were updated
05-Jun-2023	Version 2	Changed	Pre-Configured Models, Configuration Information and Core Options sections were updated.
01-May-2023	Version 1	New	New QuickSpecs.



Copyright

**Make the right purchase decision.
Contact our presales specialists.**

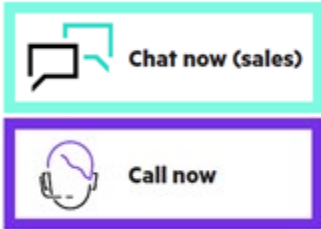

© Copyright 2023 Hewlett Packard Enterprise Development LP. The information contained herein is subject to change without notice. The only warranties for Hewlett Packard Enterprise products and services are set forth in the express warranty statements accompanying such products and services. Nothing herein should be construed as constituting an additional warranty. Hewlett Packard Enterprise shall not be liable for technical or editorial errors or omissions contained herein.

Intel® and Xeon® are registered trademarks of Intel Corporation in the U.S. and other countries. Microsoft®, Windows®, and Windows Server® are U.S. registered trademarks of the Microsoft group of companies.

For hard drives, 1GB = 1 billion bytes. Actual formatted capacity is less

a00054055enw - 16305 - Worldwide - V6 - 06-November-2023